

122.50

Cours préparatoire
à la
formation professionnelle
des
élèves conducteurs

Mathématique - Mécanique - Electricité

Planches



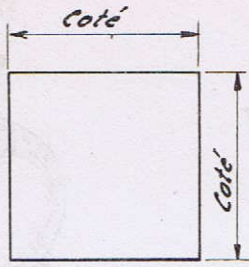

Fig. 9-1.

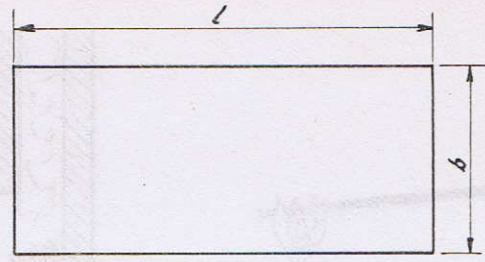

Fig. 9-2.

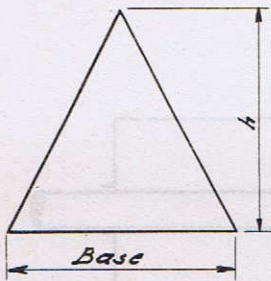

Fig. 9-3.

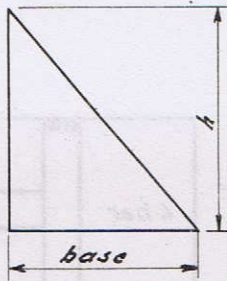

Fig. 9-4.

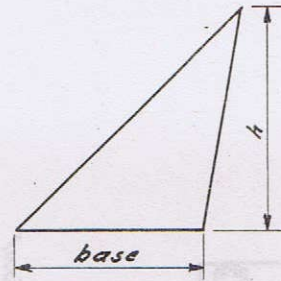

Fig. 9-5.

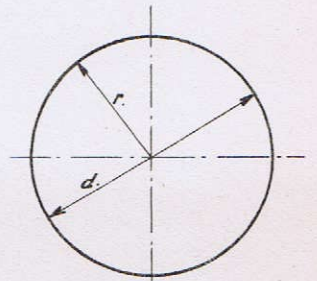

Fig. 9-6.

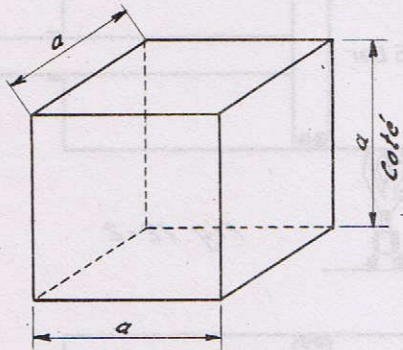

Fig. 10-1.

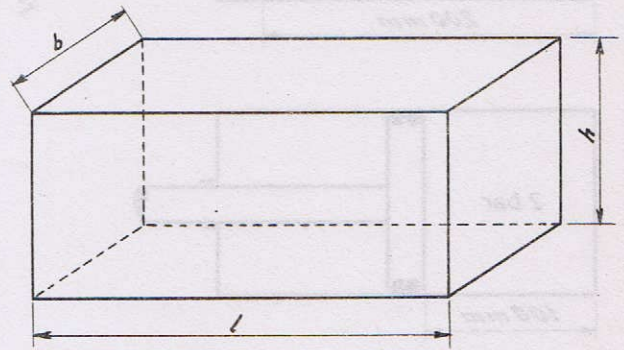

Fig. 10-2.

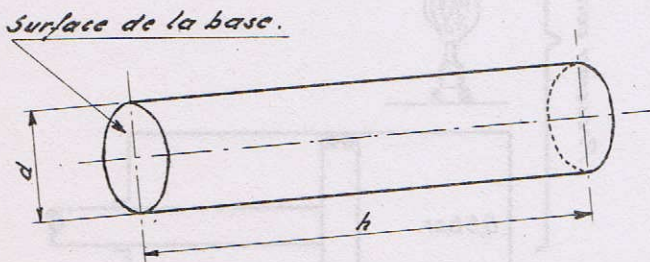

Fig. 10-3.

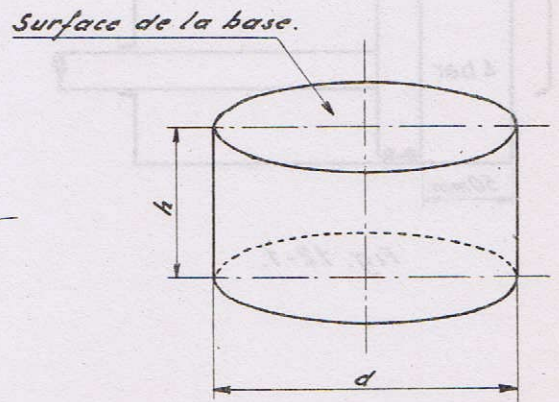

Fig. 10-4.

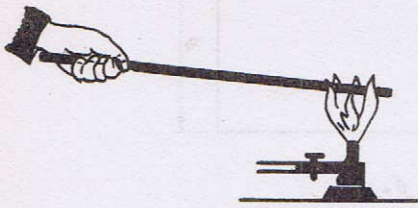

Fig. 11-1.

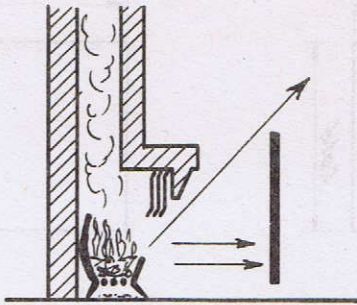

Fig. 11-2.

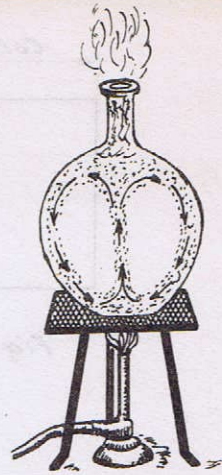

Fig. 11-3.

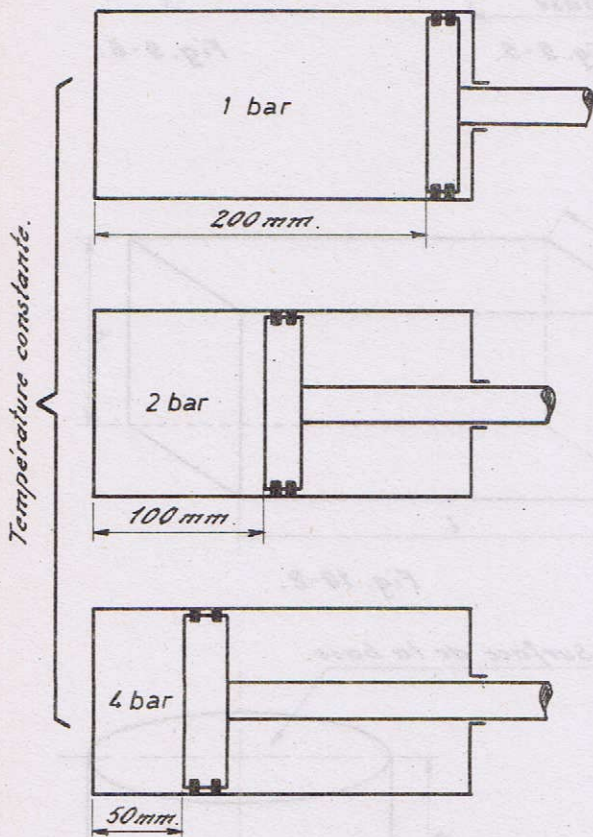

Fig. 12-1.

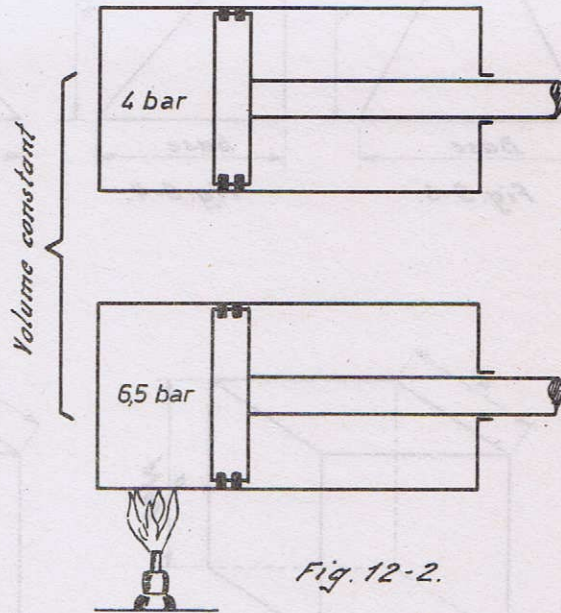

Fig. 12-2.

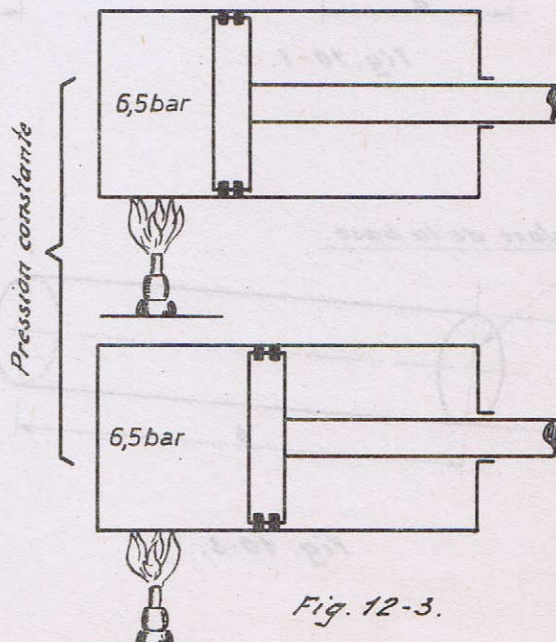

Fig. 12-3.

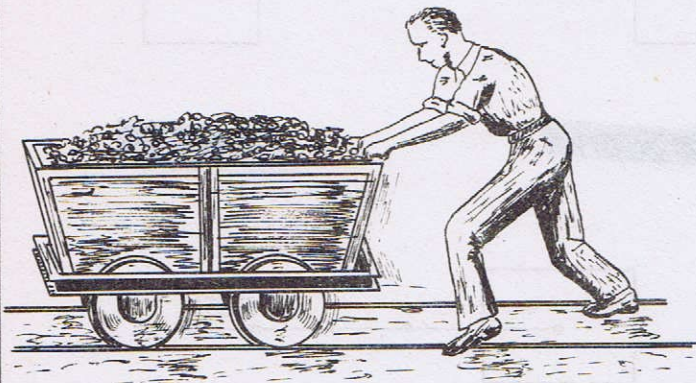

Fig. 13-1.

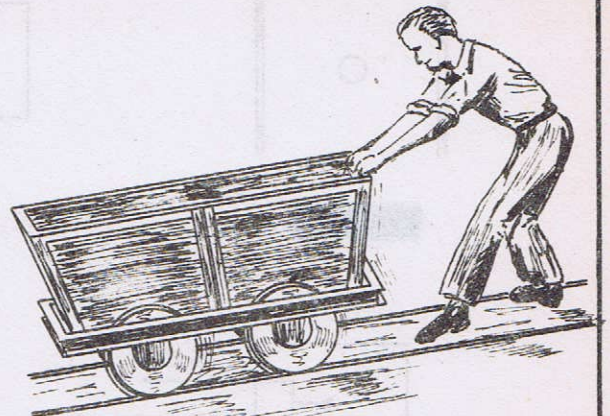

Fig. 13-2.

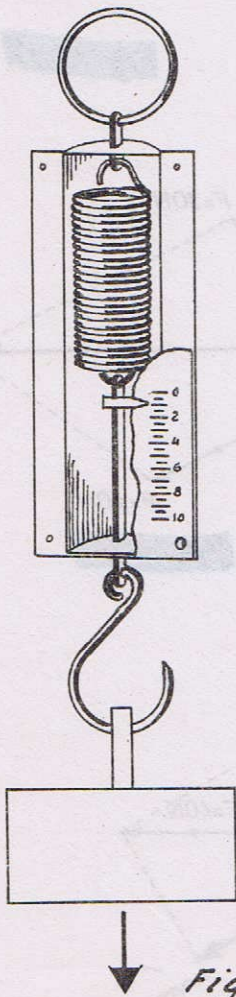

Fig. 13-3.

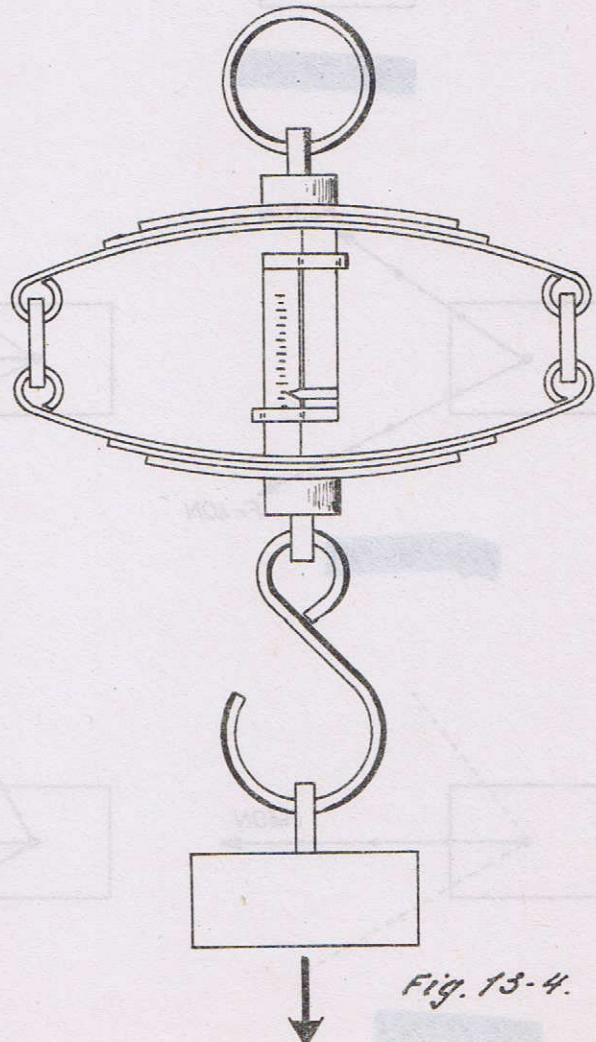

Fig. 13-4.

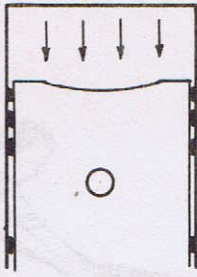

Fig. 13-5.

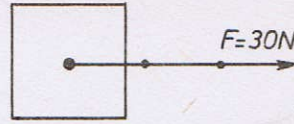

Fig. 13-6.

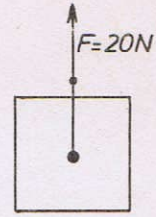

Fig. 13-7.

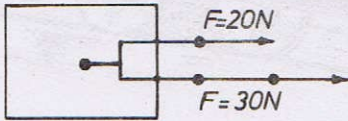

Fig. 13-8.

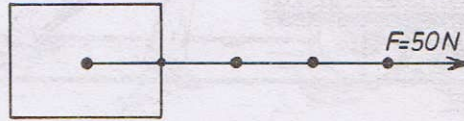

Fig. 13-9.

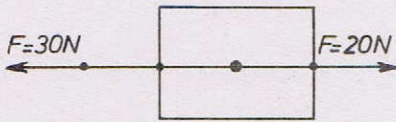

Fig. 13-10.

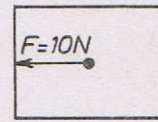

Fig. 13-11.

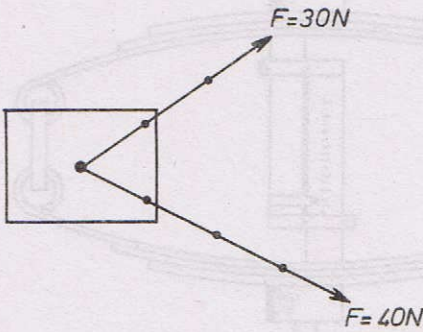

Fig. 13-12.

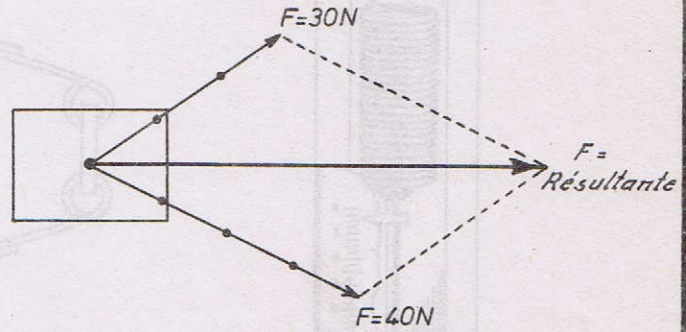

Fig. 13-13.

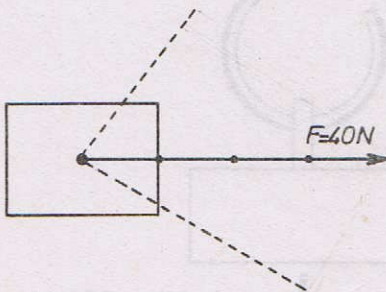

Fig. 13-14.

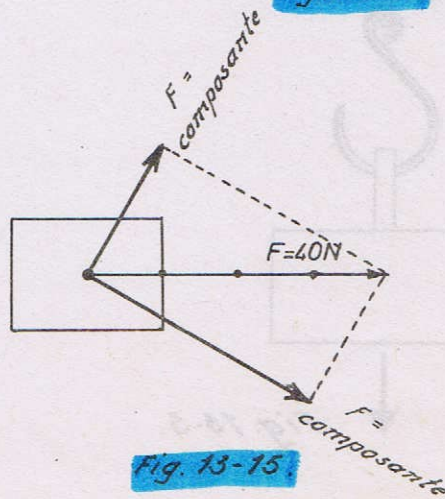

Fig. 13-15.

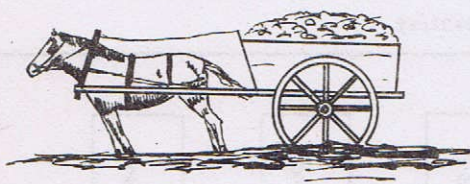

Fig. 14.1.

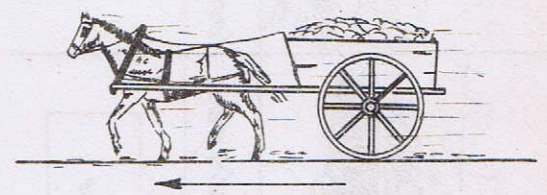

Fig. 14.2.

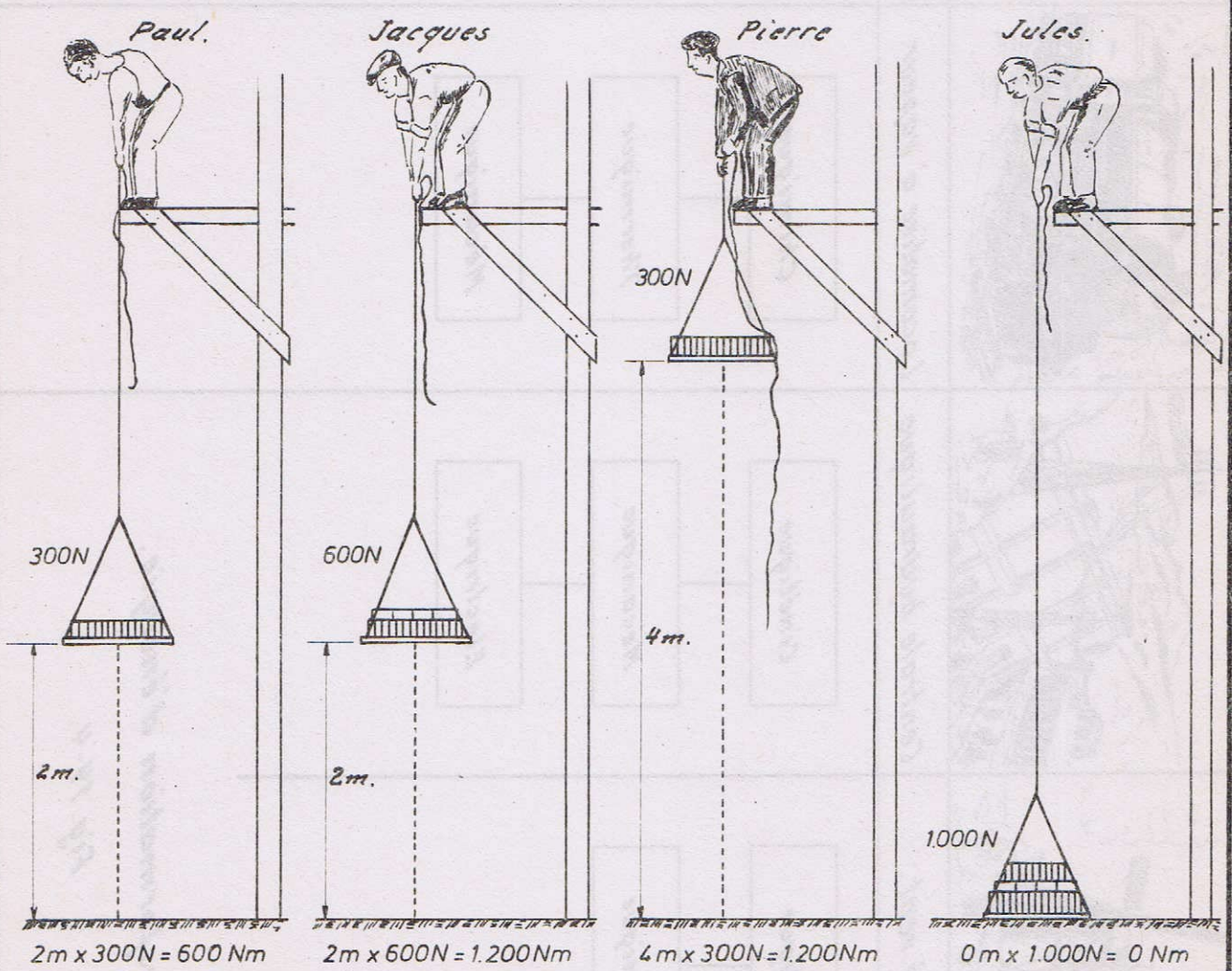
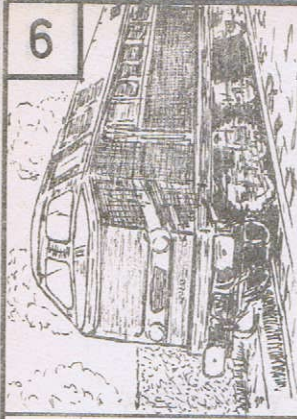
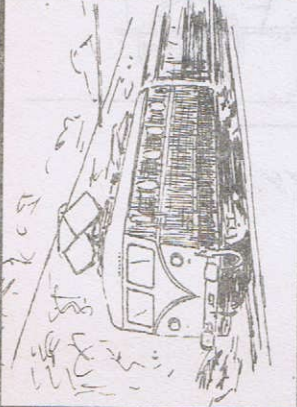
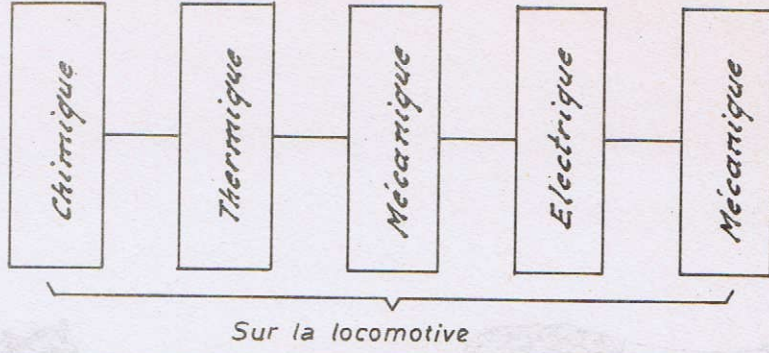

Fig. 14.3

6



Loco. Diesel électrique.



Locomotive électrique.

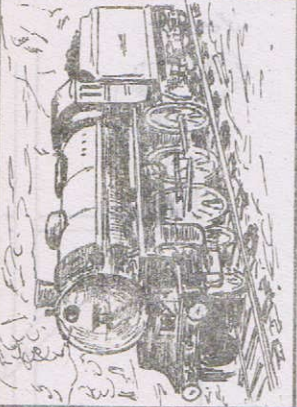
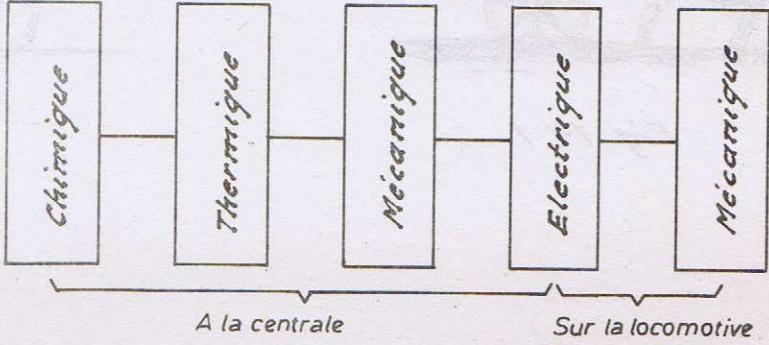

Locomotive à vapeur.

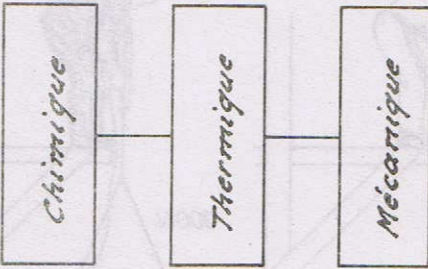

Centrale hydraulique.

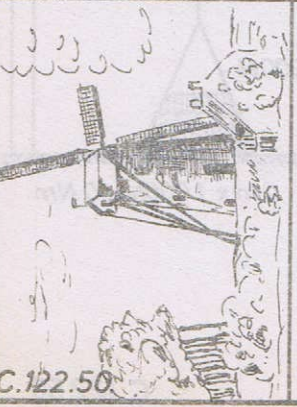
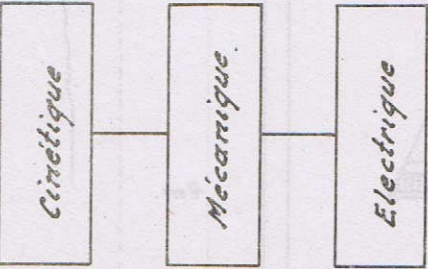

Moulin à vent.

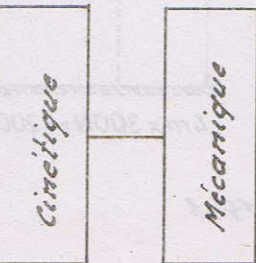

Transformation d'énergie.

Fig. 14-4.

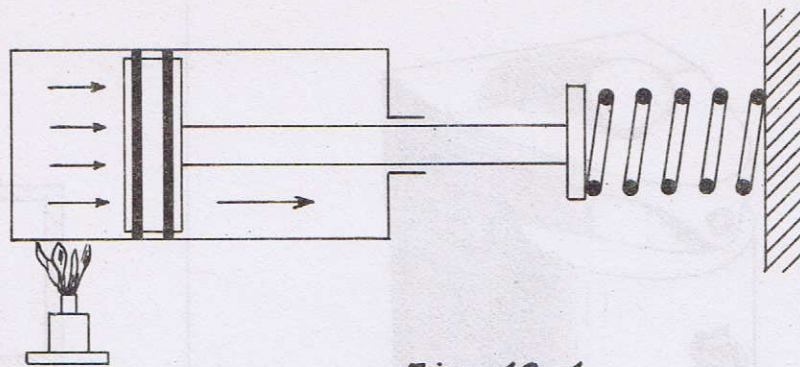
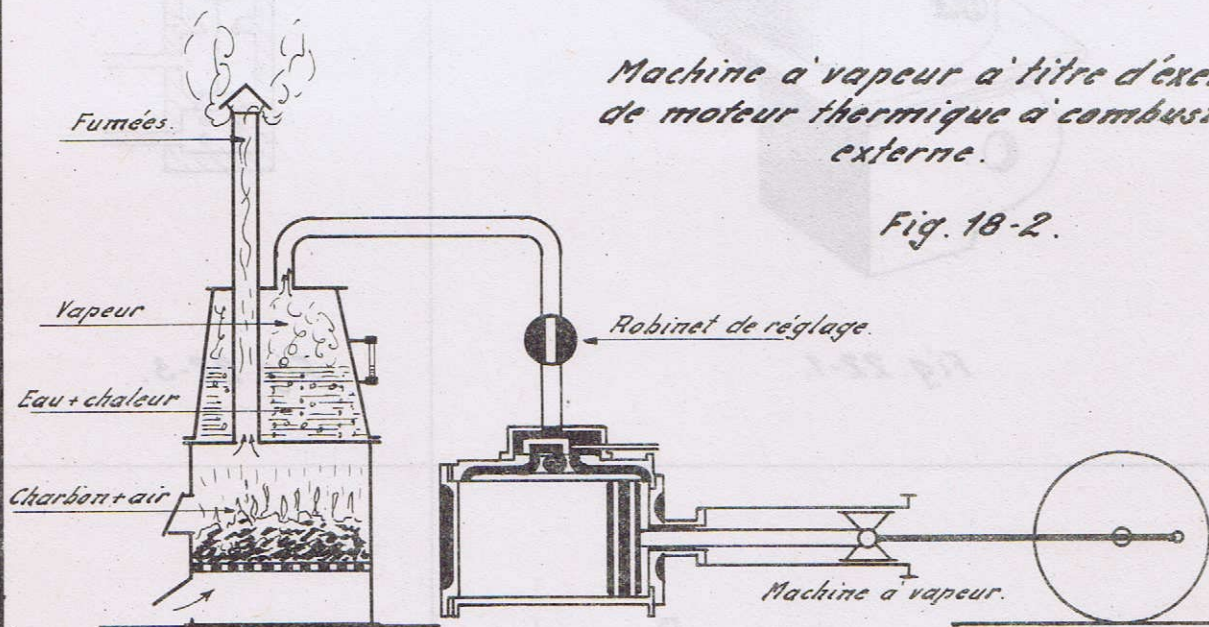

Fig. 18-1.

Machine à vapeur à titre d'exemple de moteur thermique à combustion externe.

Fig. 18-2.



Transformation chaleur en énergie mécanique.

Principe du moteur thermique à combustion interne.

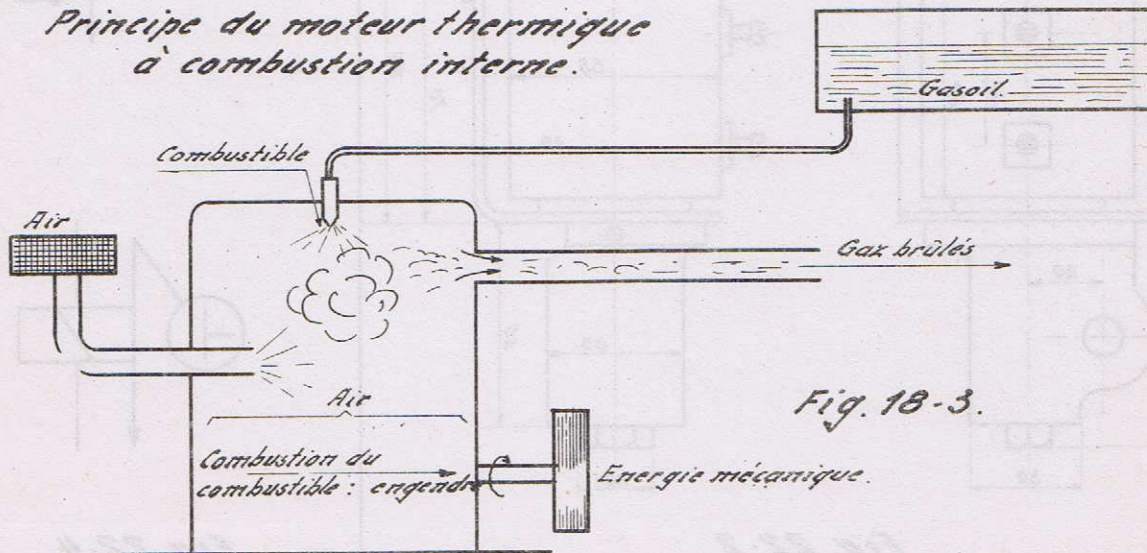

Fig. 18-3.

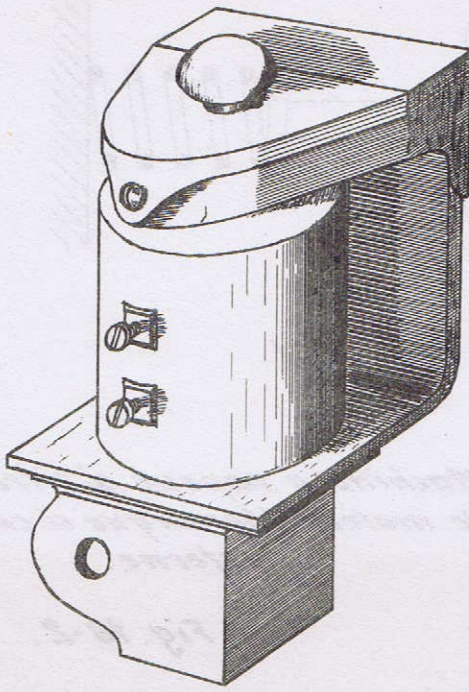

Fig. 22-1.

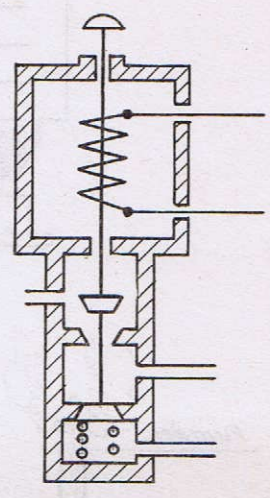

Fig. 22-3.

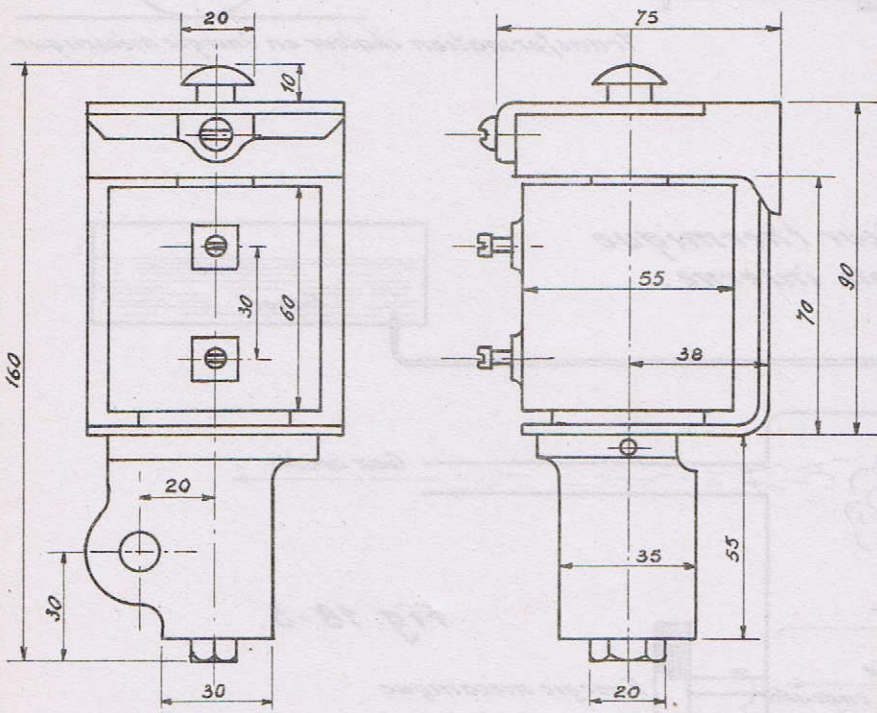

Fig. 22-2

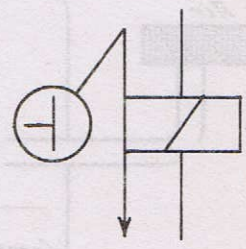
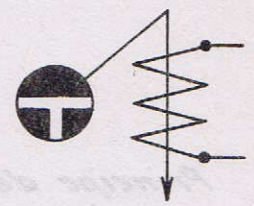

Fig. 22-4.

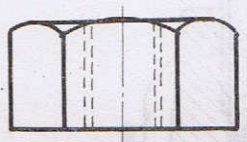

Fig. 23.1.

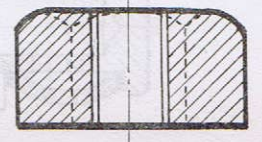

Fig. 23.2.

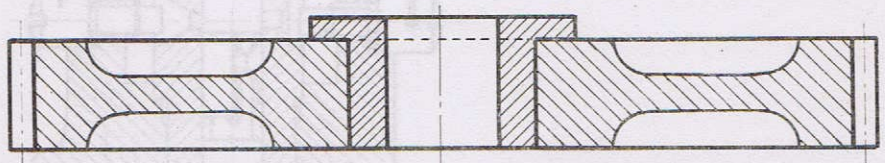

Fig. 23.3.

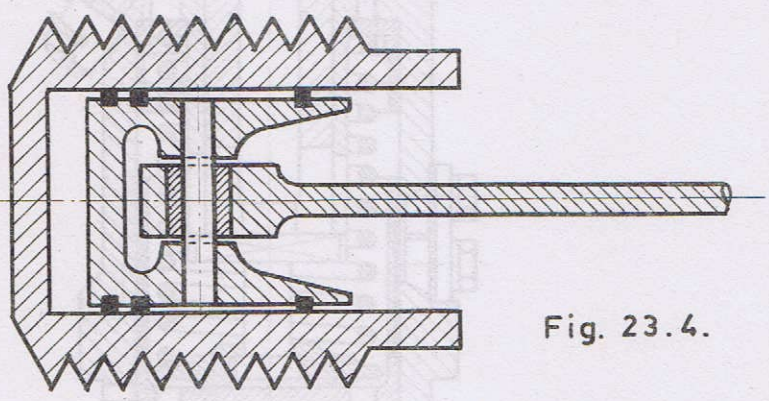

Fig. 23.4.

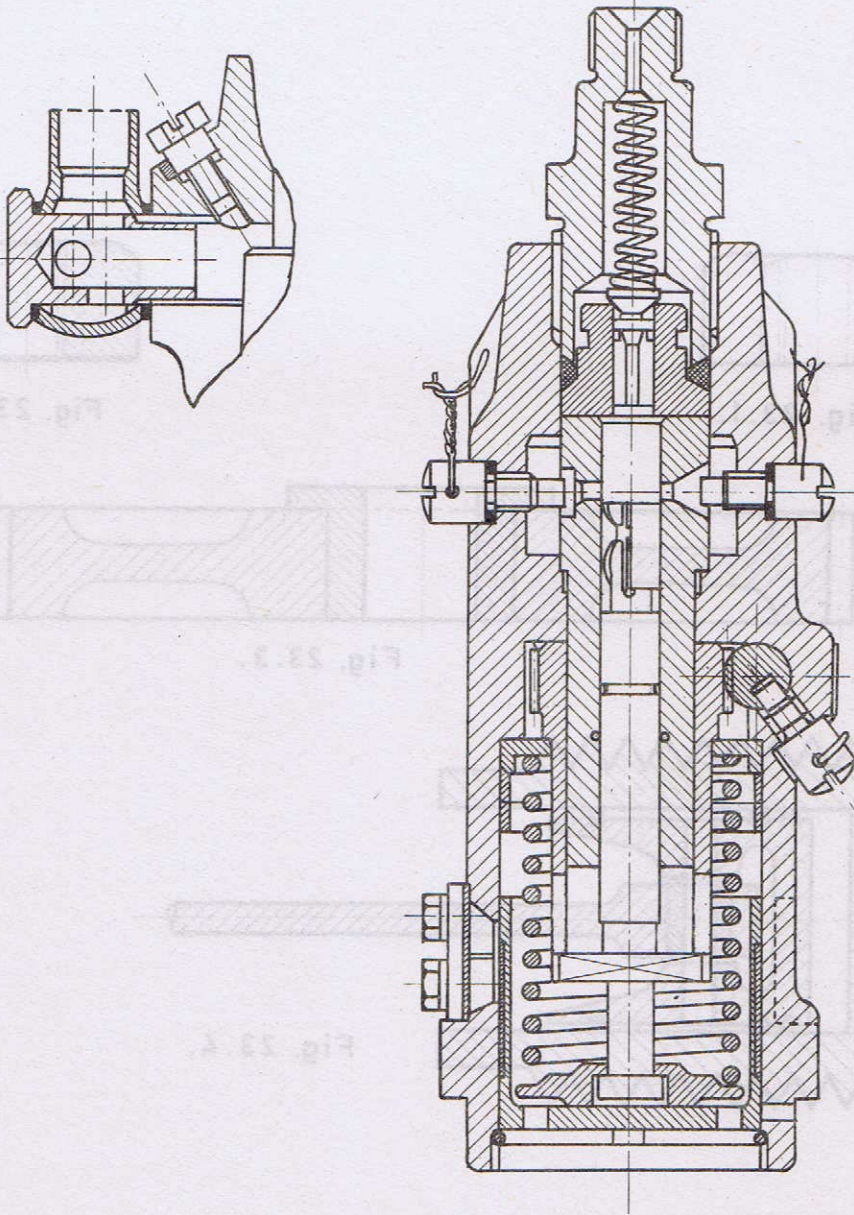

Fig. 24-3.

Coupe d'une pompe d'injection.

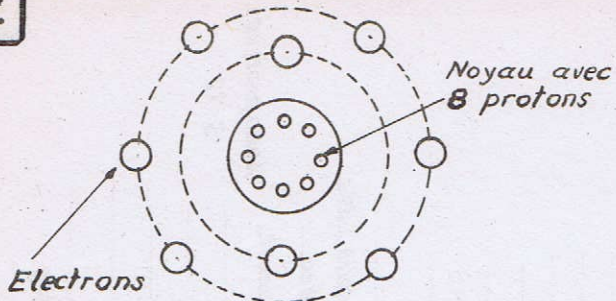

Fig. 25.1.

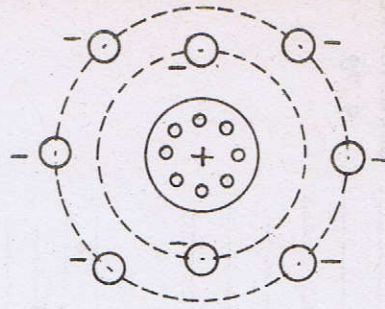

Fig. 25.2.

Valeur + = Valeur ..

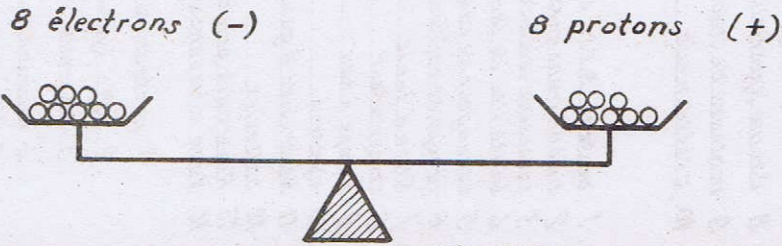
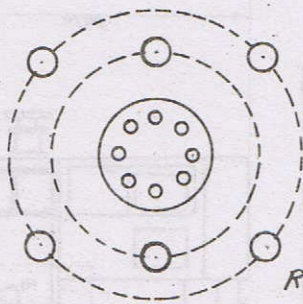

Fig. 25.3.



6 electrons (-)

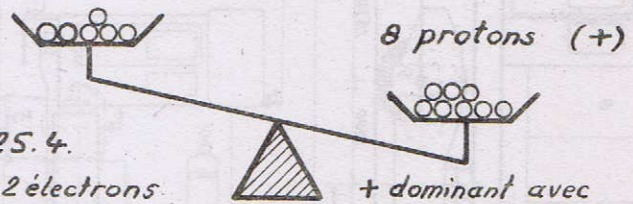
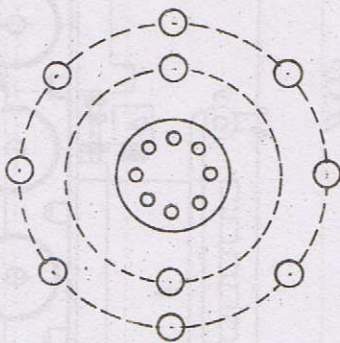

Fig. 25.4.

Retrait de 2 électrons



10 electrons (-)

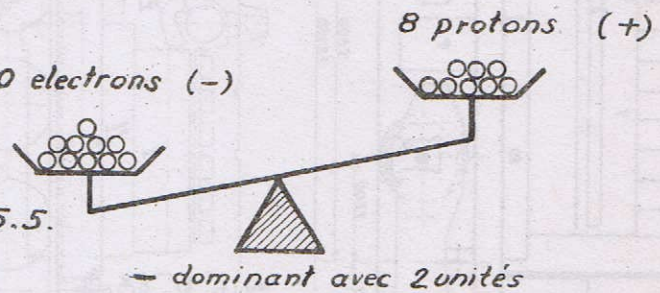

Fig. 25.5.

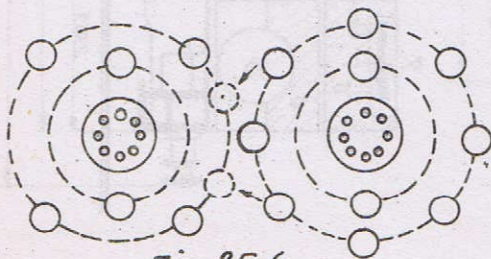

Fig 25.6.

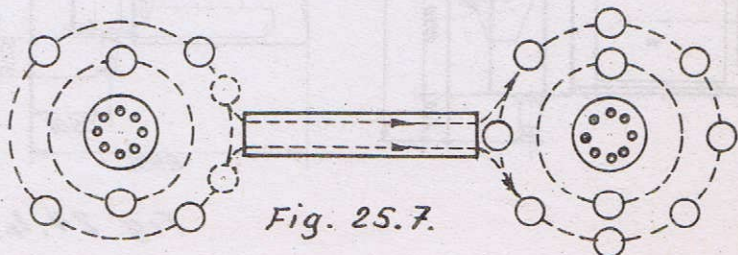

Fig. 25.7.

Fig. 25.8

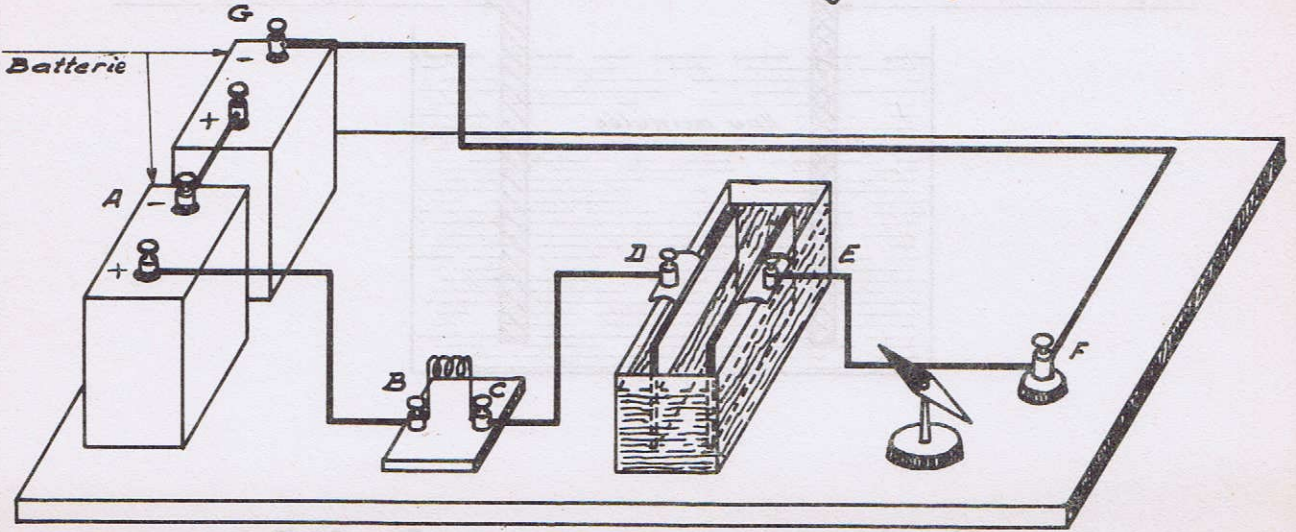

Fig. 25.9.

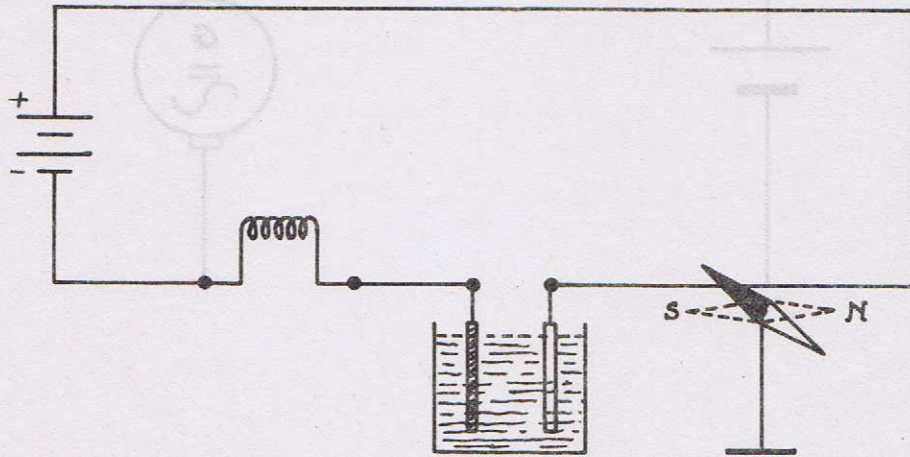

Fig. 25.10

Fig. 25.11.

Fig. 25.12

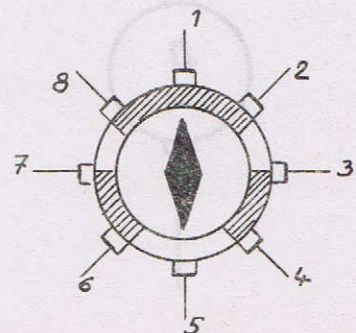
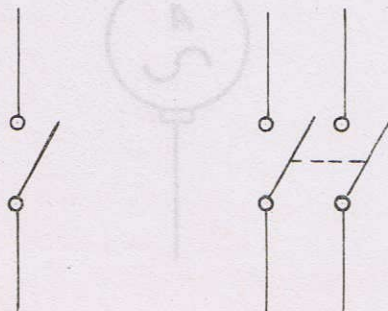

Fig. 26.1

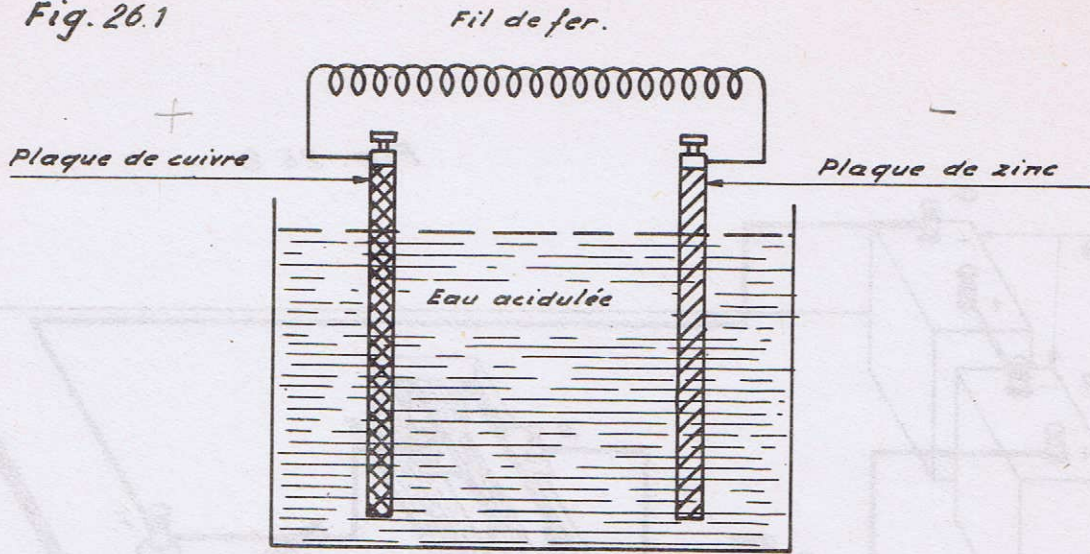

Fig. 26.2.



Fig. 26.3

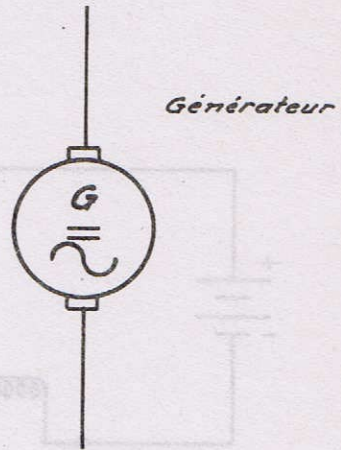

Fig. 26.4.

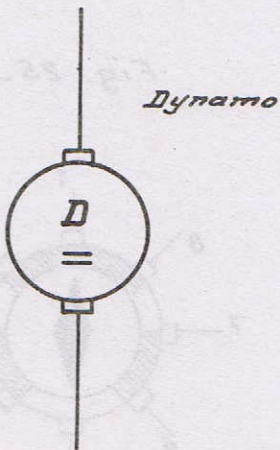

Fig. 26.5.

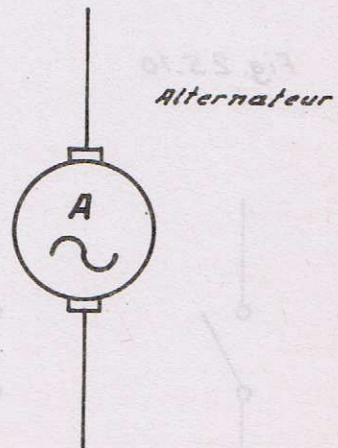

Fig. 27.1.

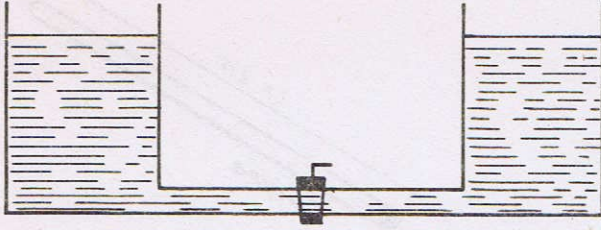

Fig. 27.3

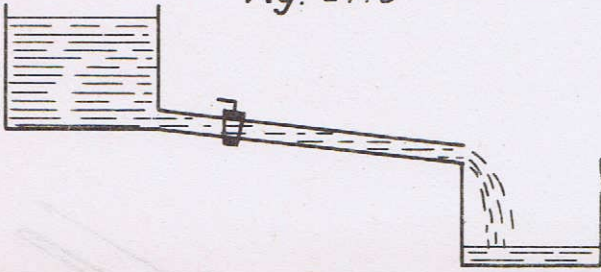

Fig. 27.5

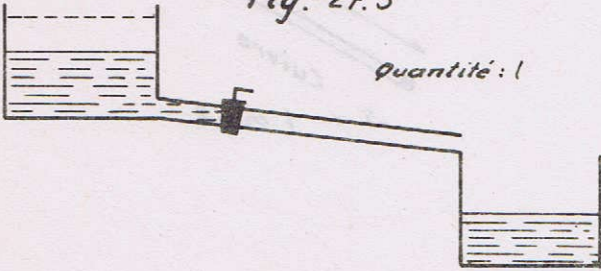

Fig. 27.7

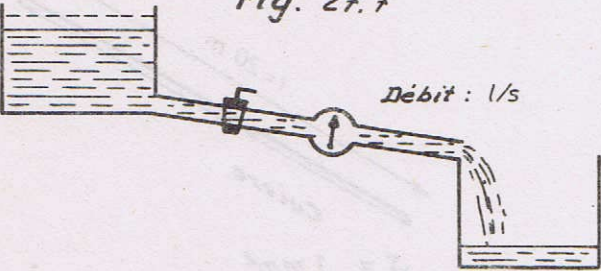

Fig. 27.9.

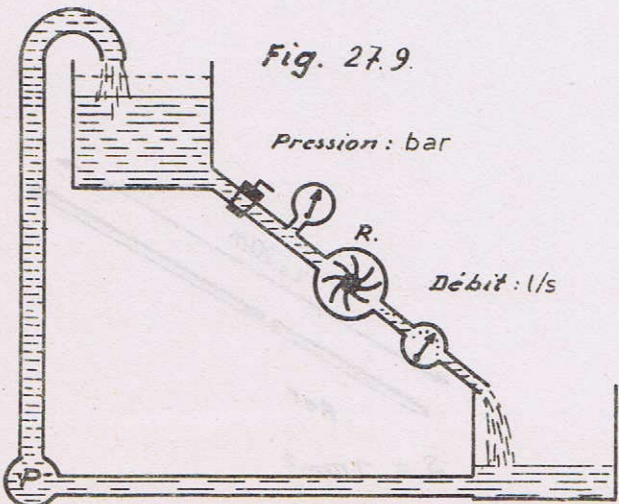

Fig. 27.2.

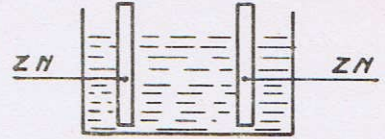

Fig. 27.4

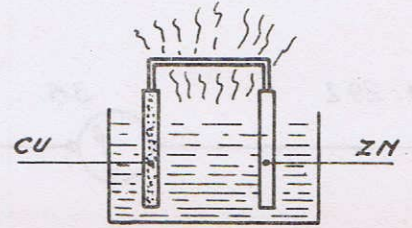

Fig. 27.6.

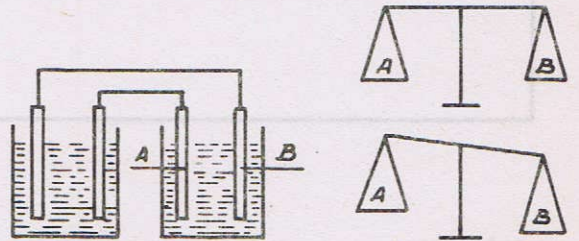

Fig. 27.8

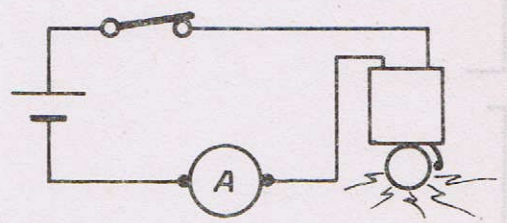

Fig. 27.10

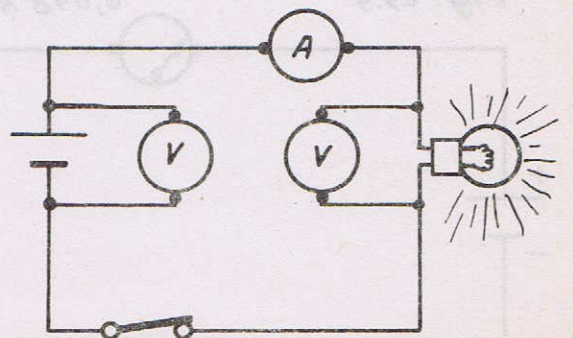
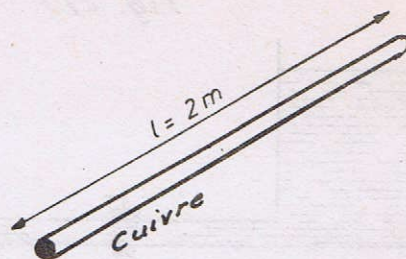
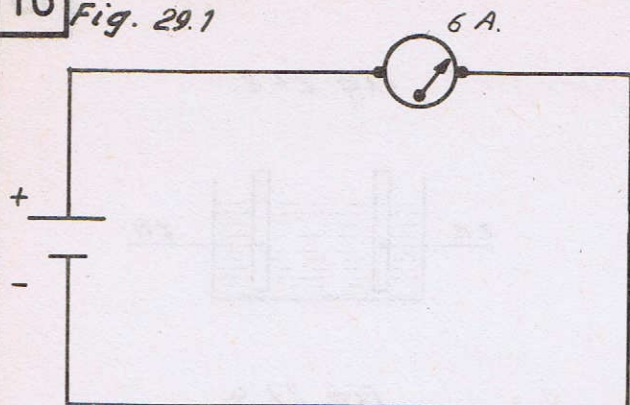
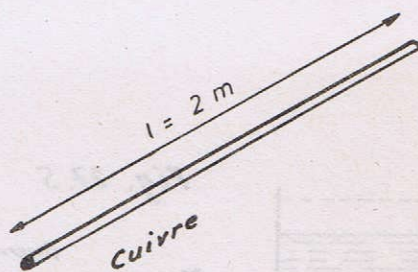
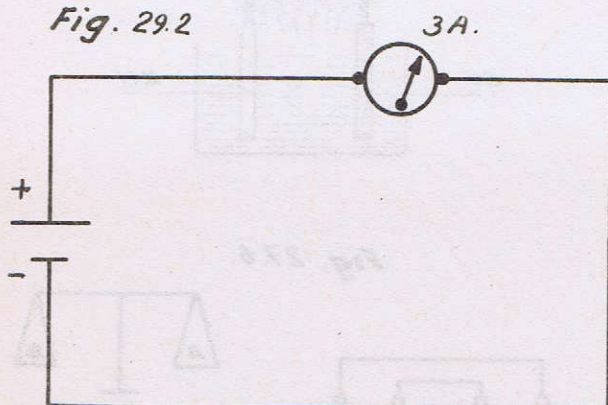

Fig. 29.1



$$S = 2 \text{ mm}^2.$$

Fig. 29.2



$$S = 1 \text{ mm}^2$$

Fig. 29.3

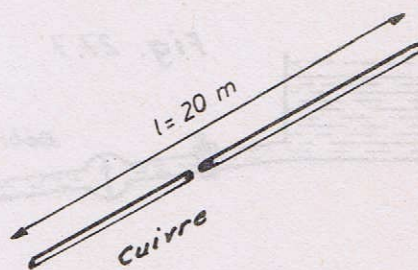
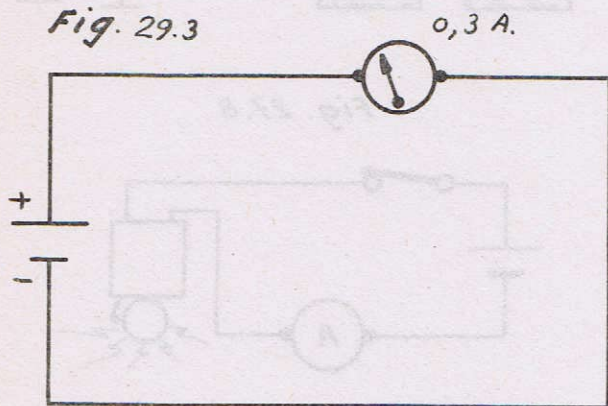

$$S = 1 \text{ mm}^2$$

Fig. 29.4

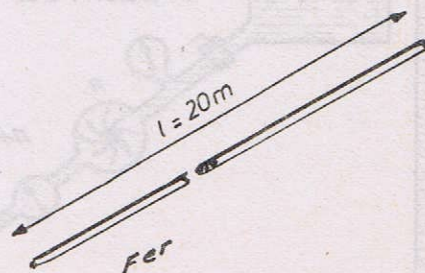
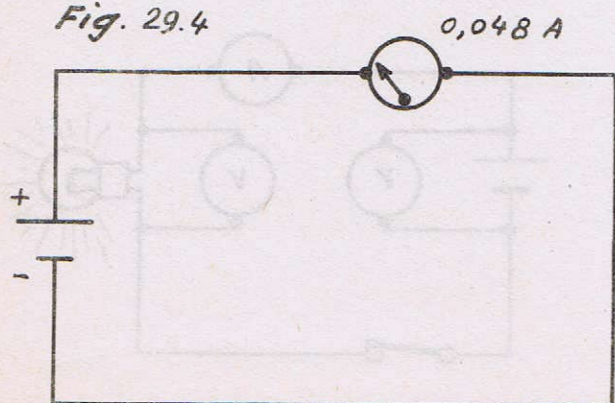

$$S = 1 \text{ mm}^2$$

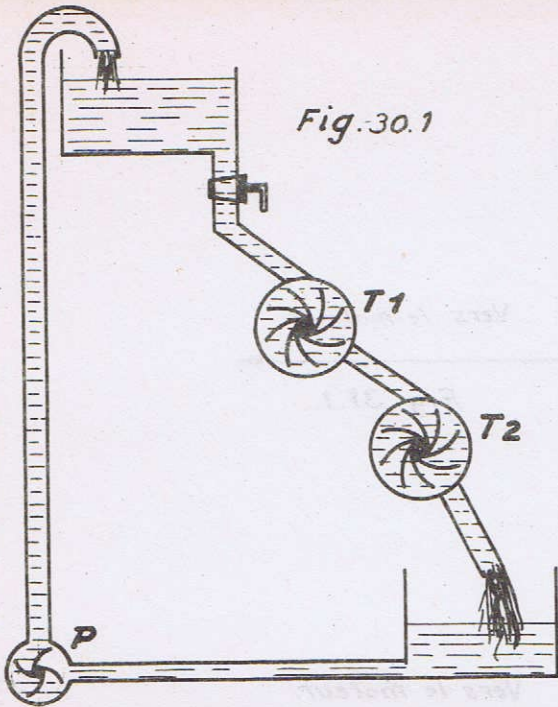

Fig. 30.1

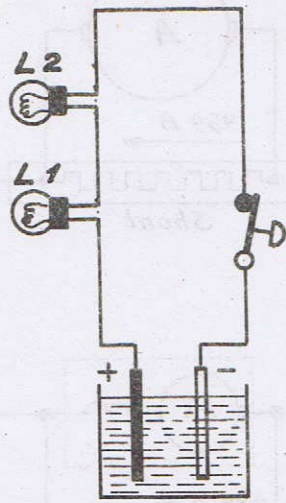

Fig. 30.2

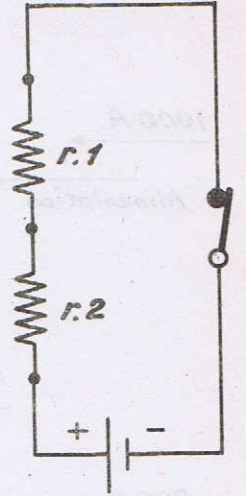

Fig. 30.3

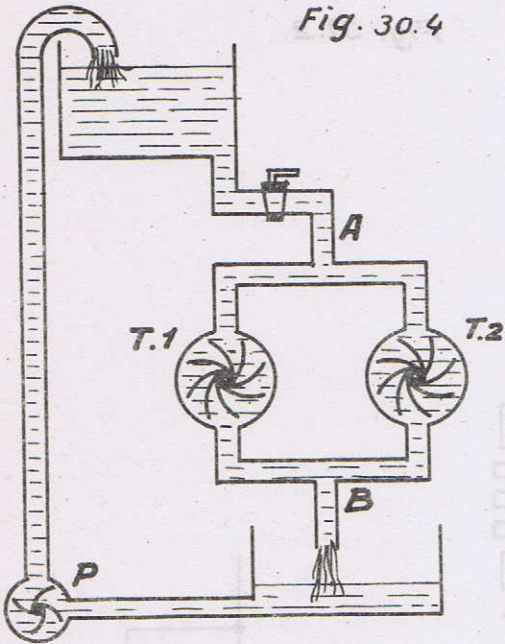

Fig. 30.4

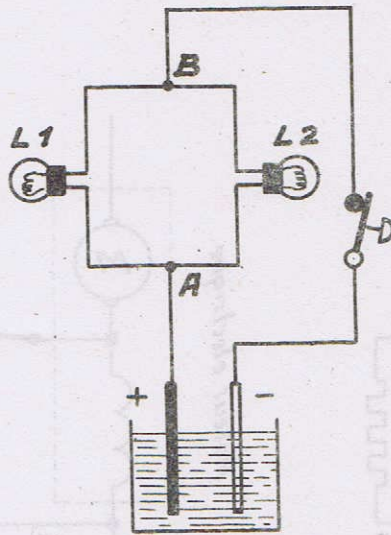

Fig. 30.5

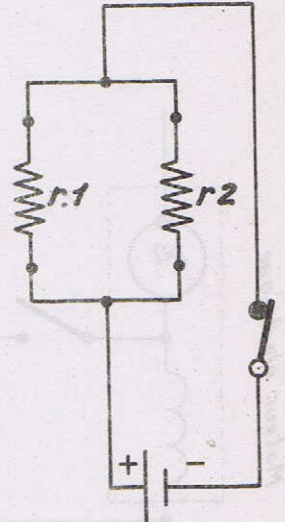

Fig. 30.6

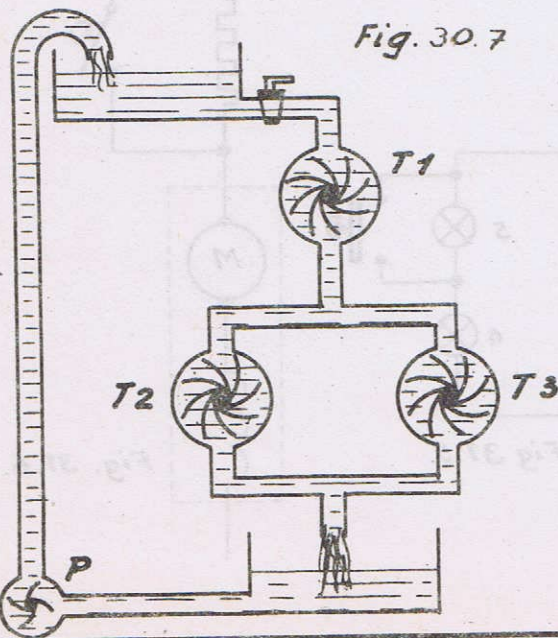

Fig. 30.7

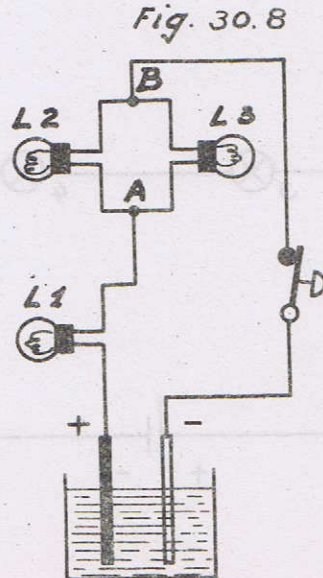

Fig. 30.8

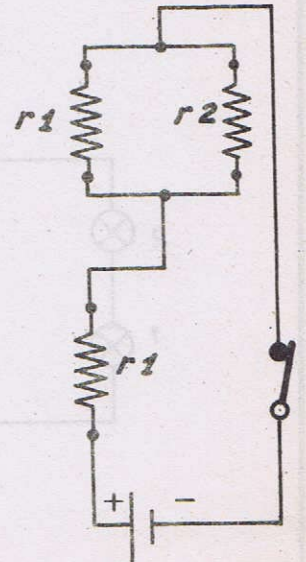
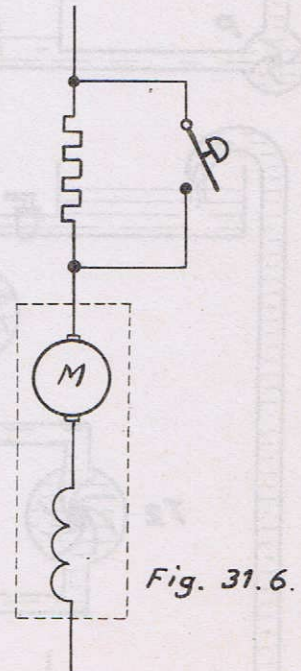
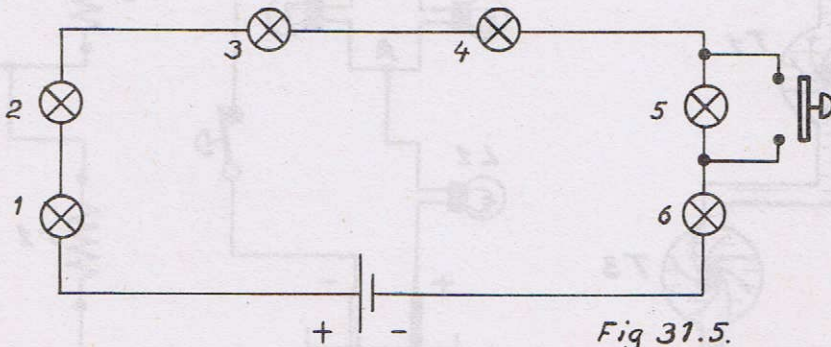
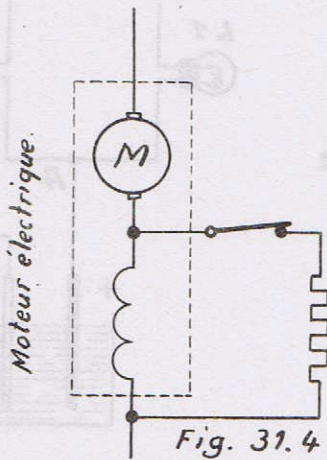
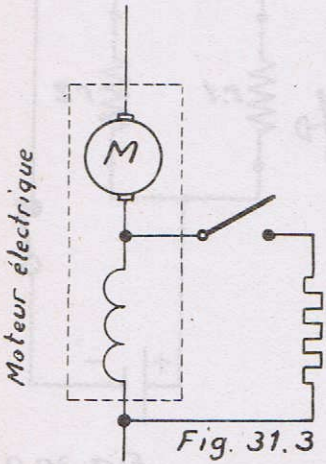
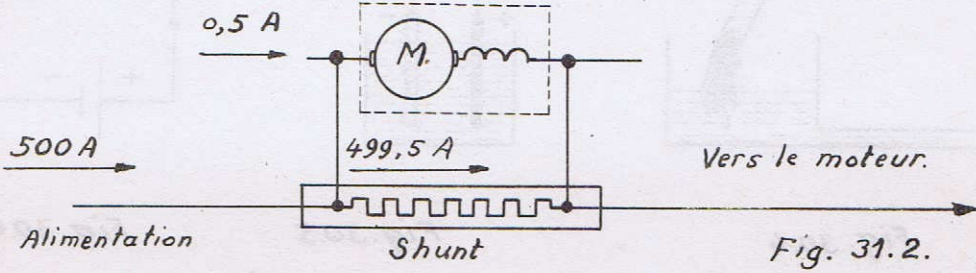
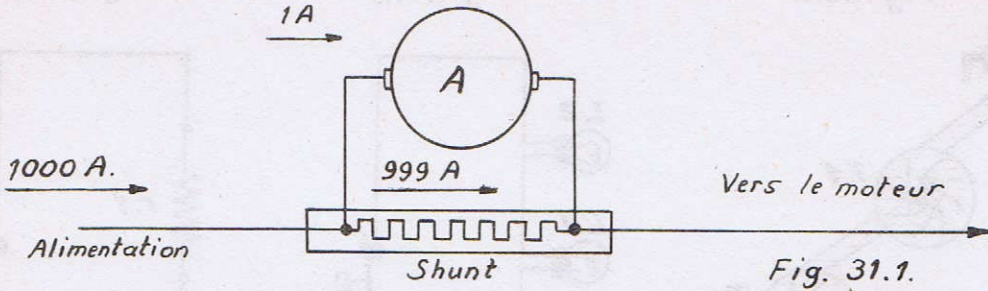
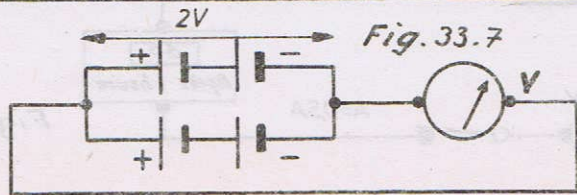
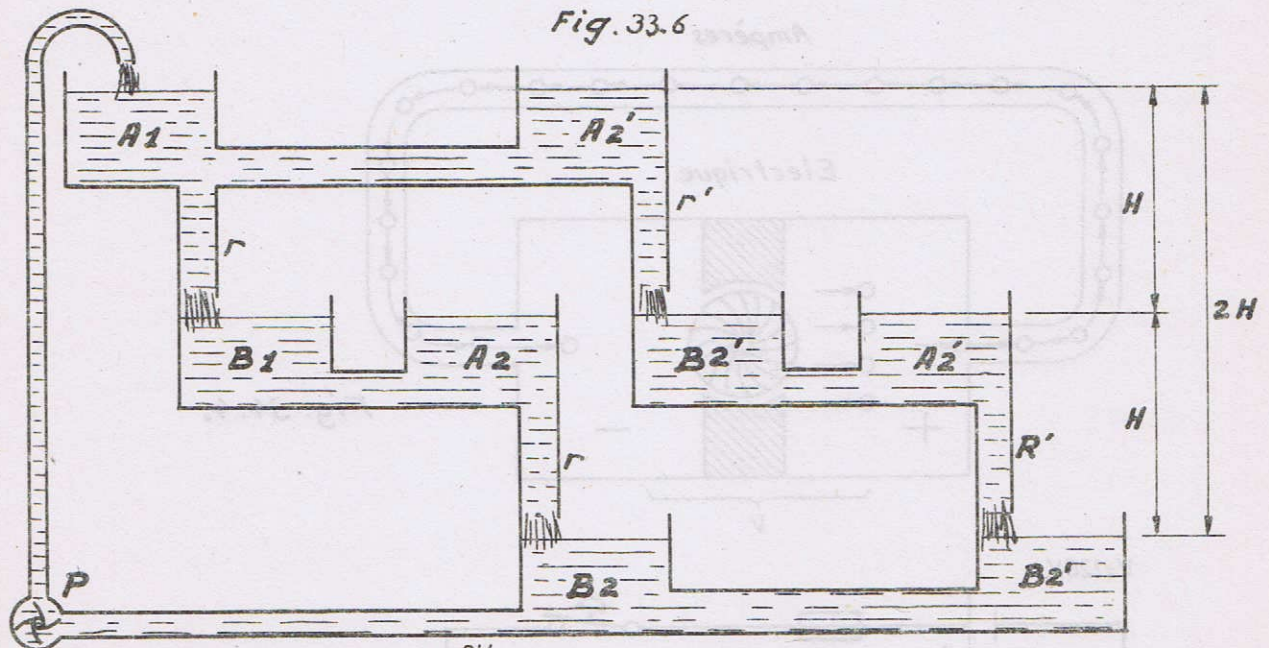
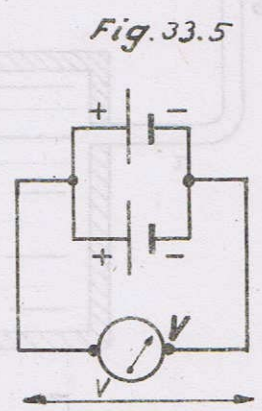
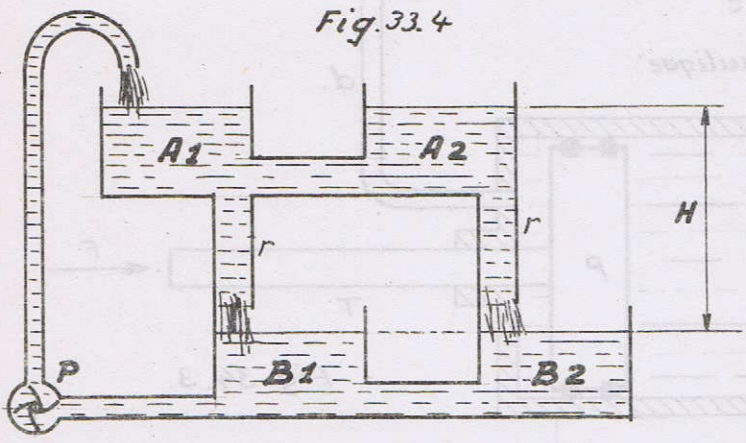
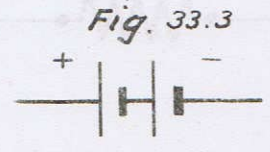
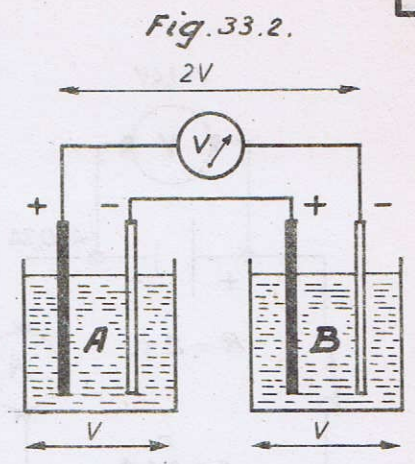
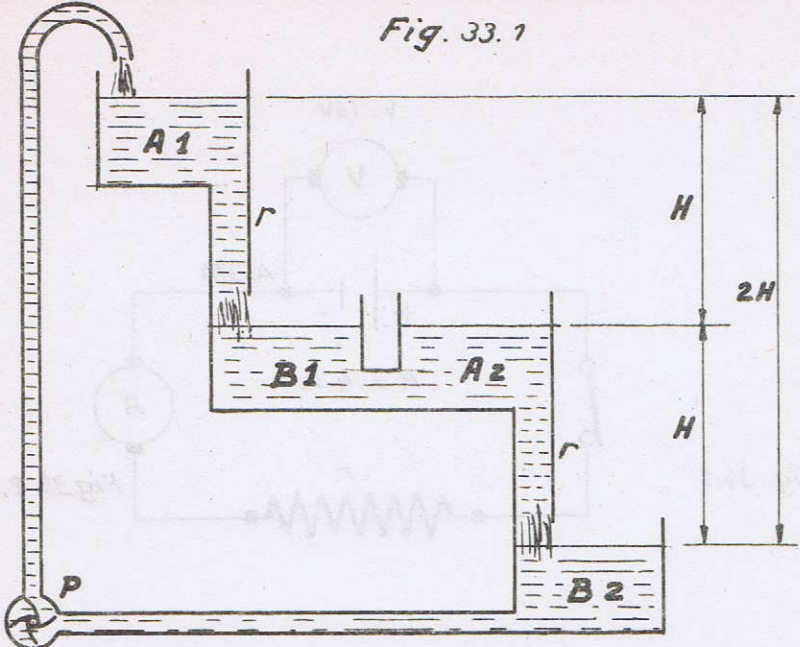

Fig. 30.9





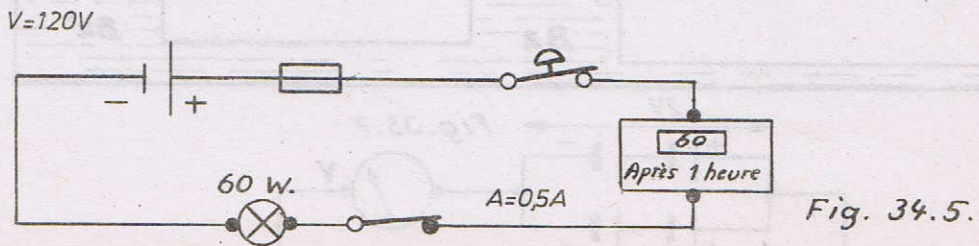
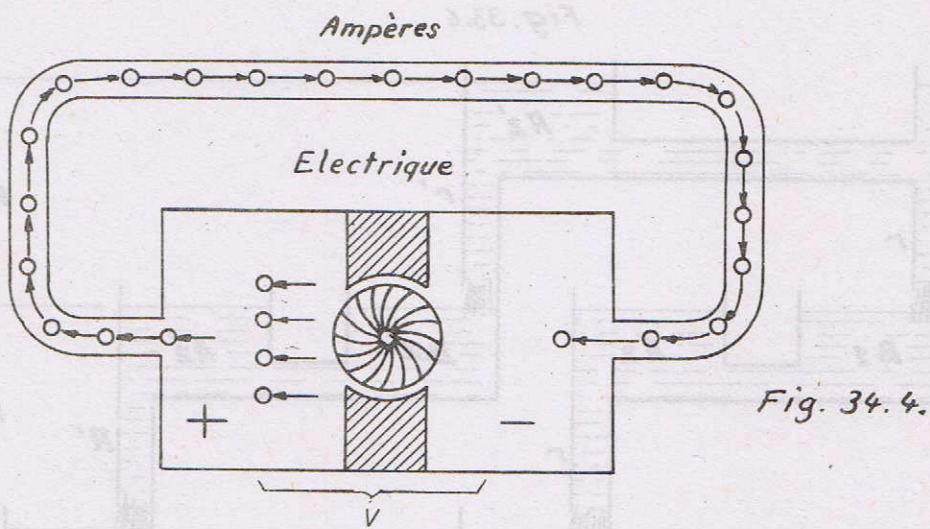
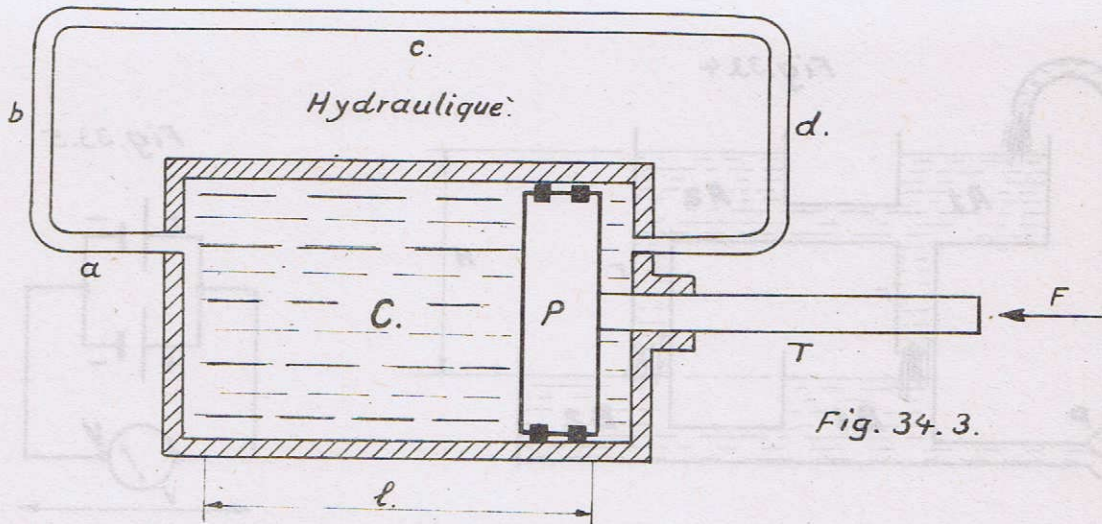
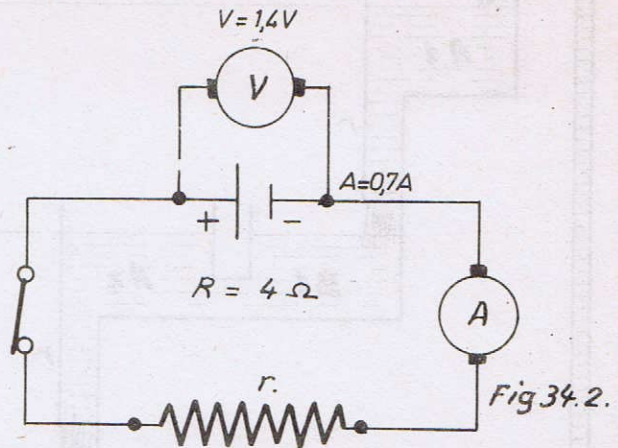
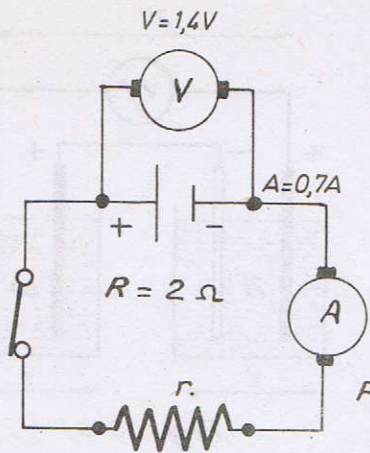

Fig. 35.1

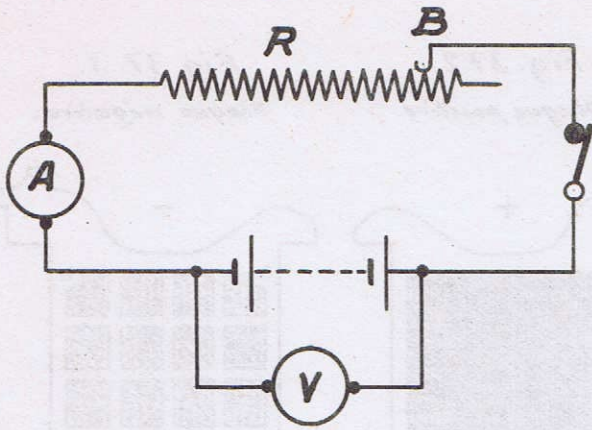

Fig. 35.2.

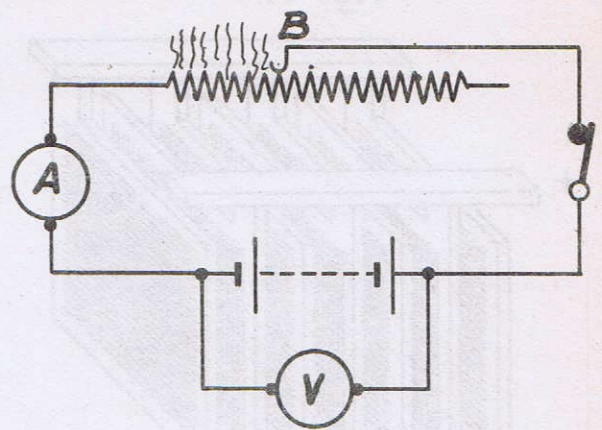

Fig. 35.3

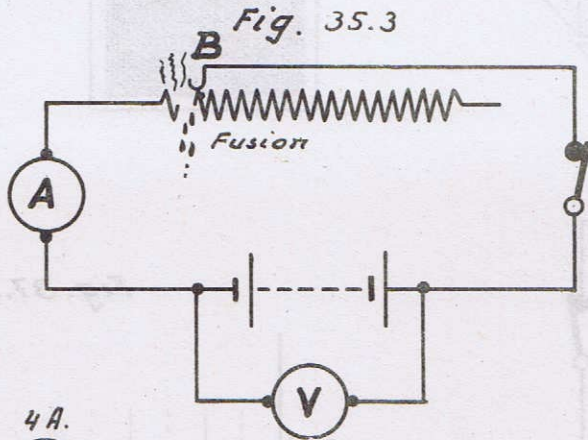

Fig. 35.4

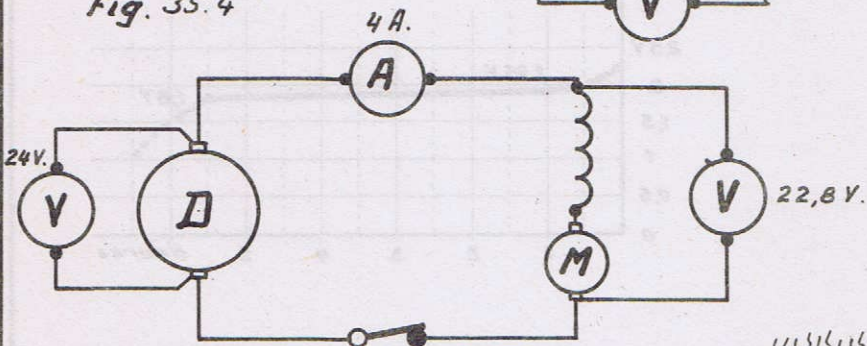

Fig. 35.5

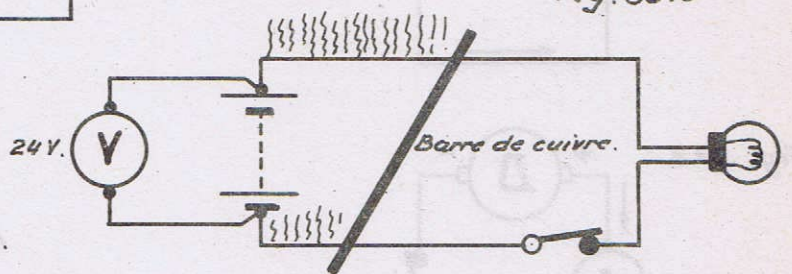

Fig. 35.6

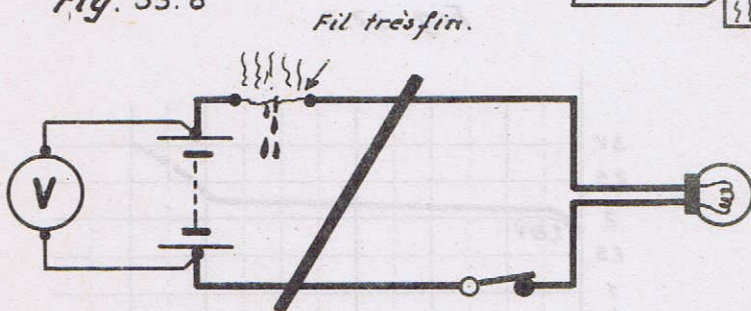

Fig. 35.7.



Fig. 37.1

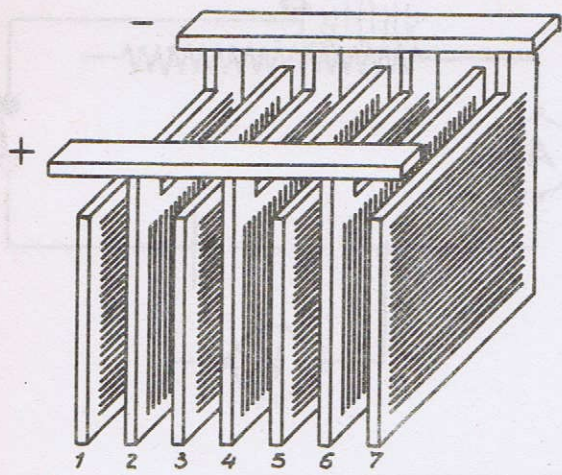

Fig. 37.2.
Plaque positive.

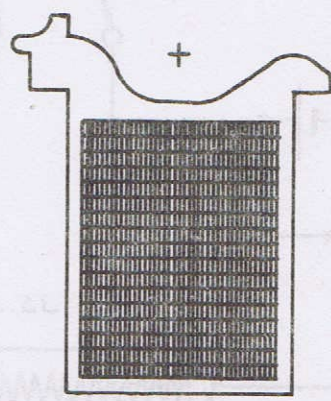

Fig 37.3.
Plaque négative.

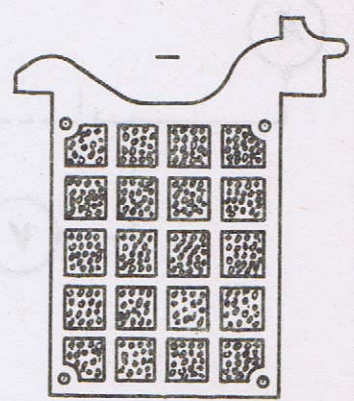

Fig. 37.4

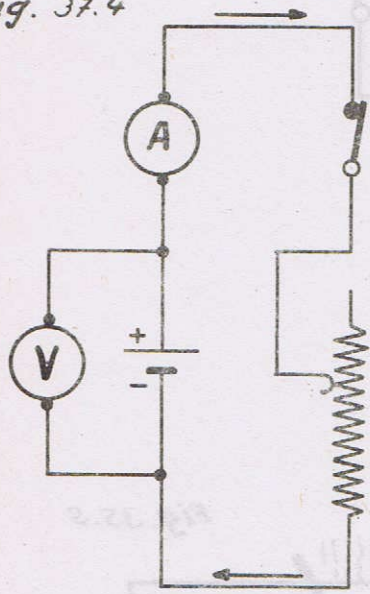

Fig. 37.5

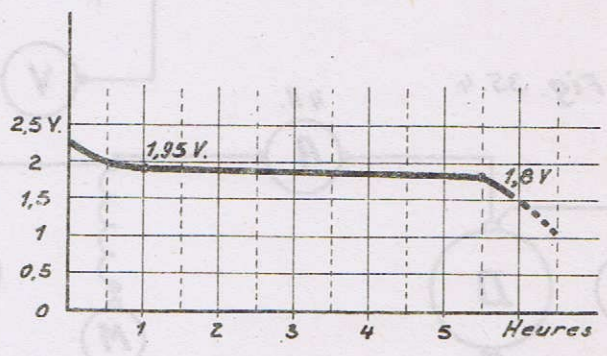

Fig. 37.6

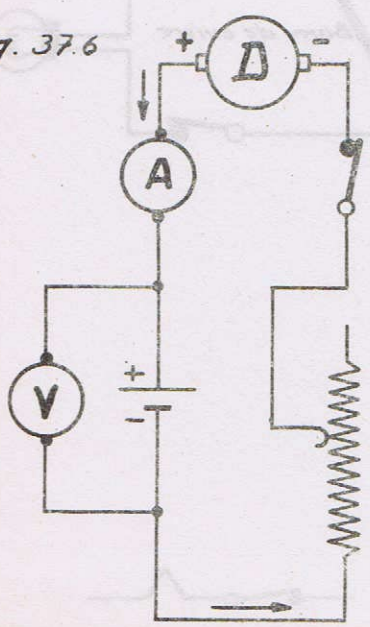
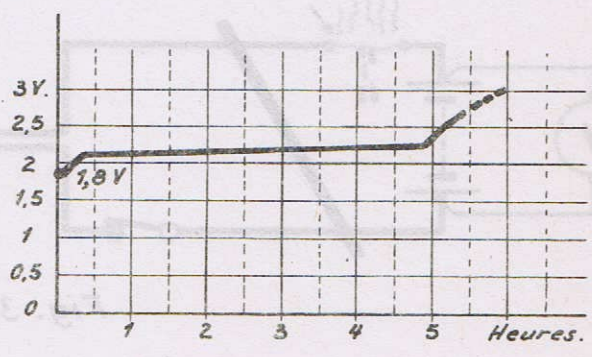

Fig. 37.7



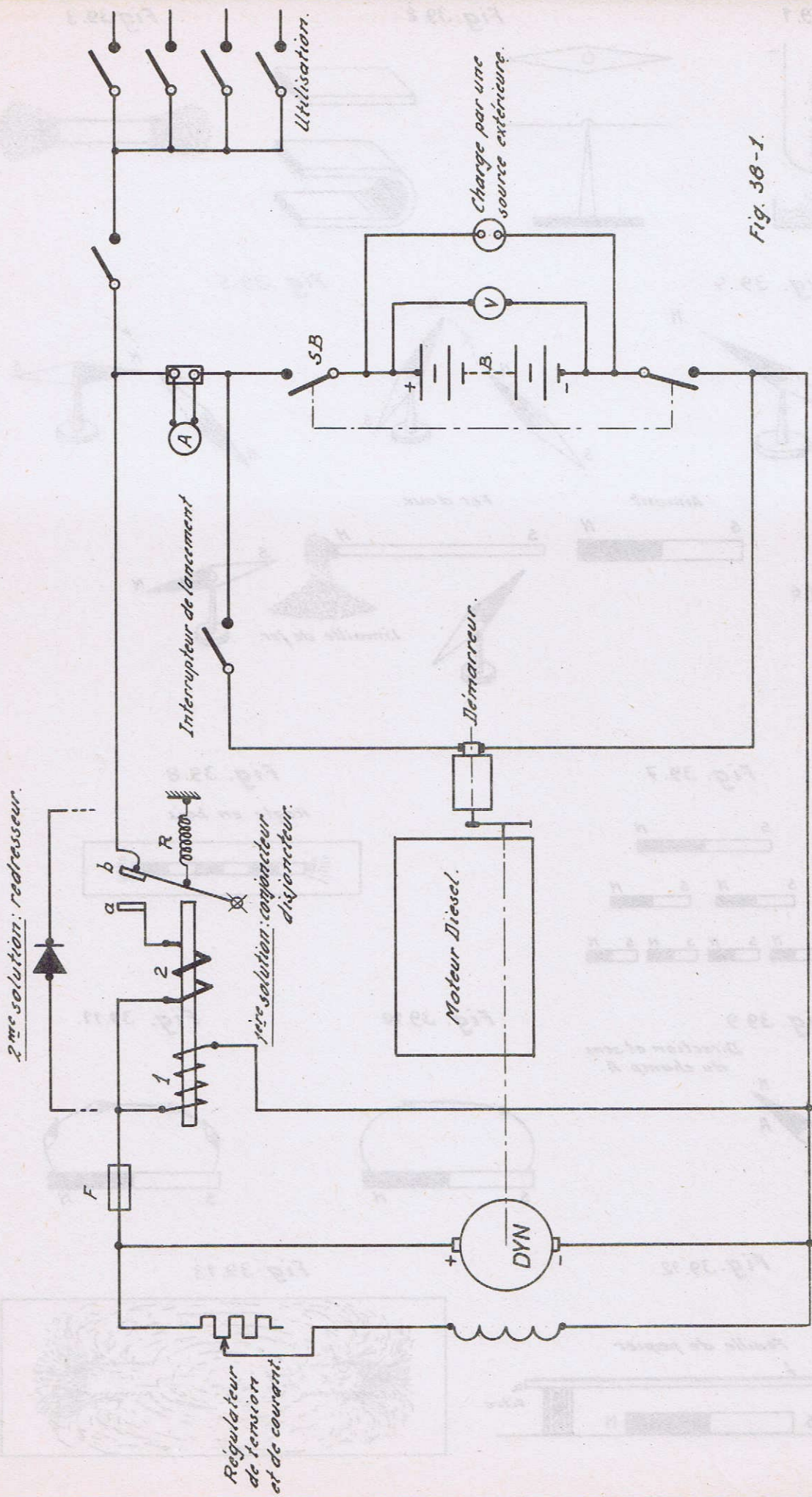

Fig. 38-1.

Circuit de charge batterie.

Fig. 39.1

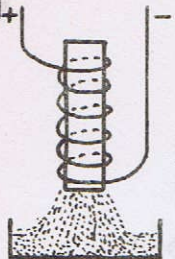

Fig. 39.2

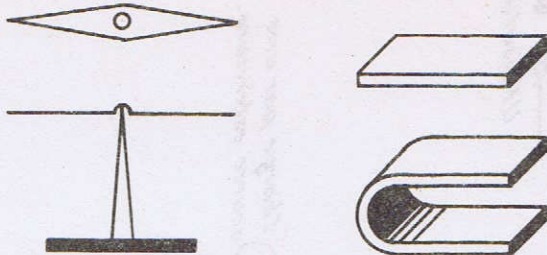

Fig. 39.3

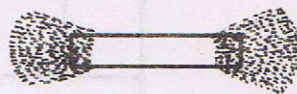

Fig. 39.4



Fig. 39.5

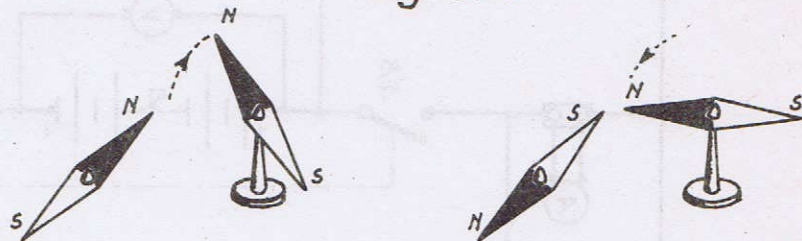

Fig. 39.6

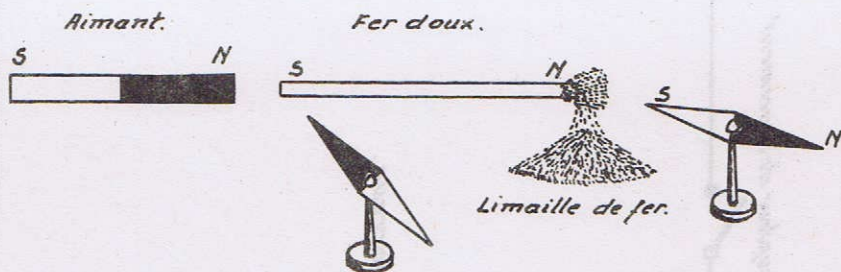

Fig. 39.7

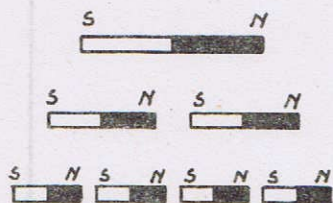

Fig. 39.8

Règle en bois



Fig. 39.9

Direction et sens du champ A.



Fig. 39.10

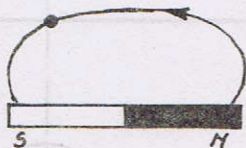

Fig. 39.11.

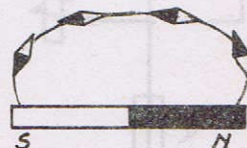

Fig. 39.12

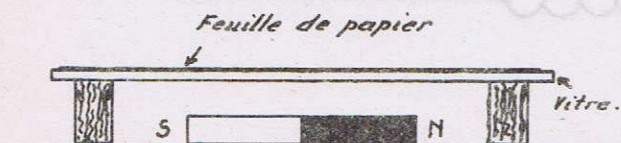

Fig. 39.13



Fig. 41.1

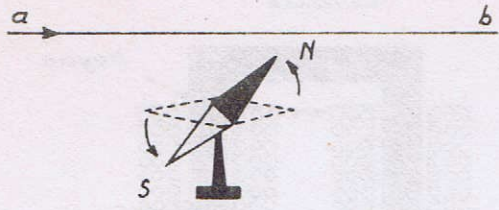

Fig 41.3

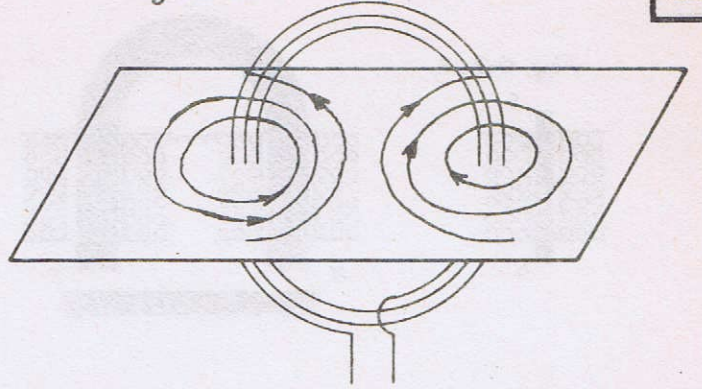

Fig. 41.2

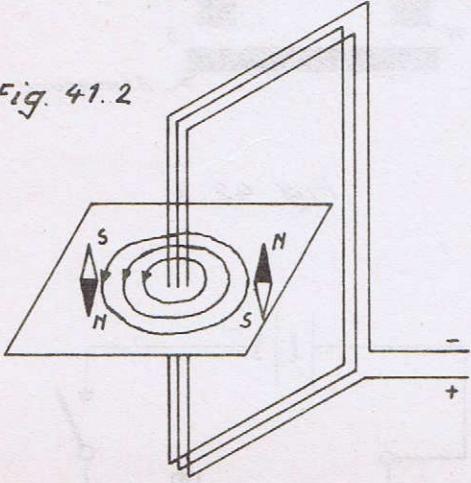

Fig. 41.4.

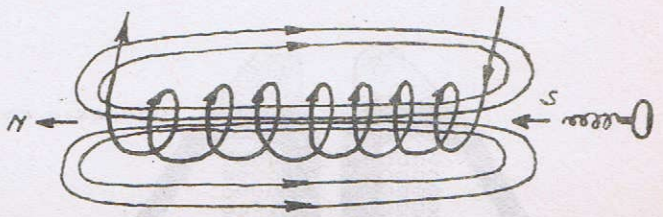

Fig 41.6

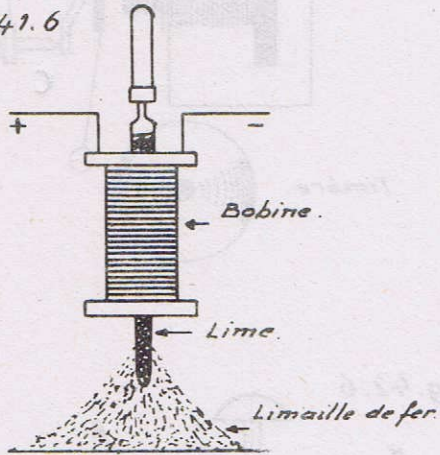

Fig. 41.5

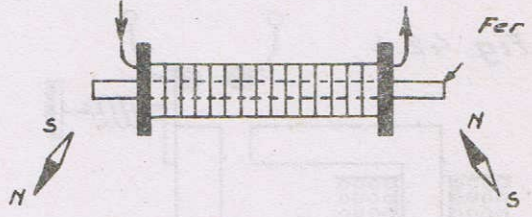

Fig. 41.7

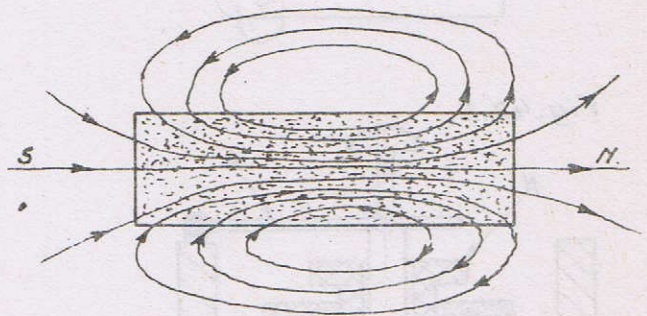

Fig. 41.8

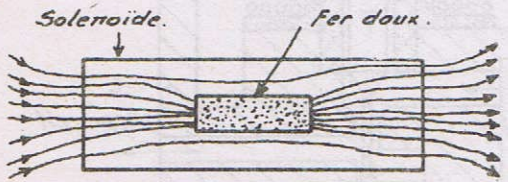
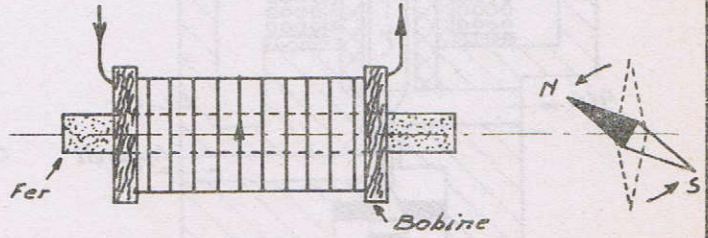

Fig. 41.9



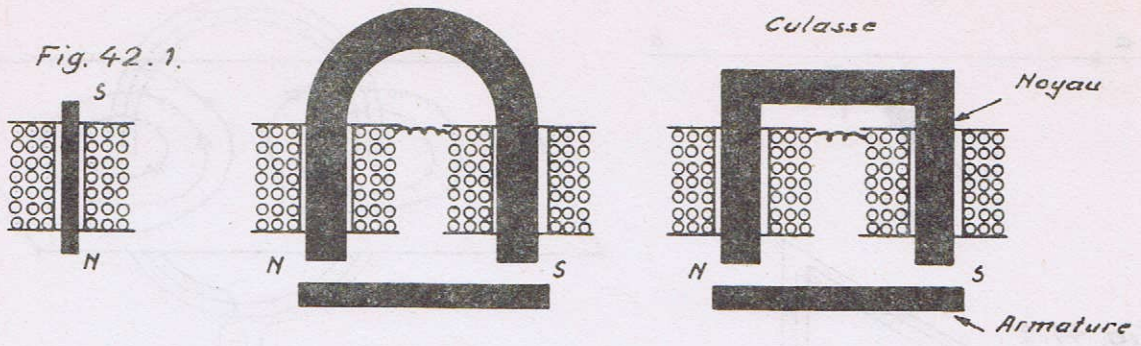

Fig. 42.2.

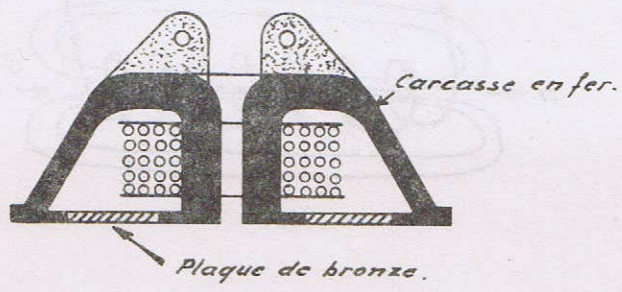

Fig. 42.3

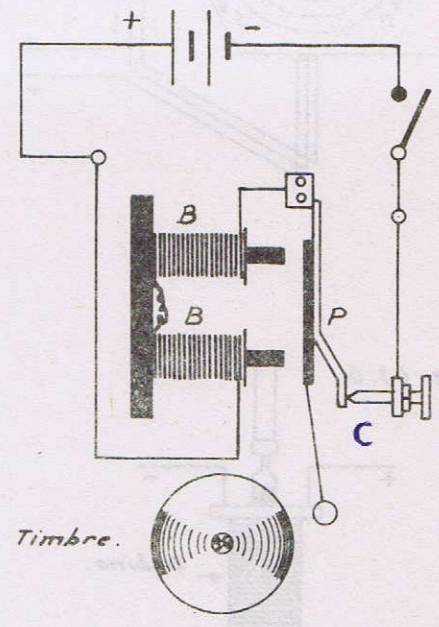

Fig. 42.4.

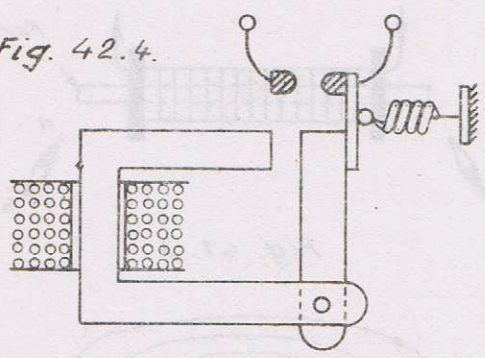

Fig. 42.5.

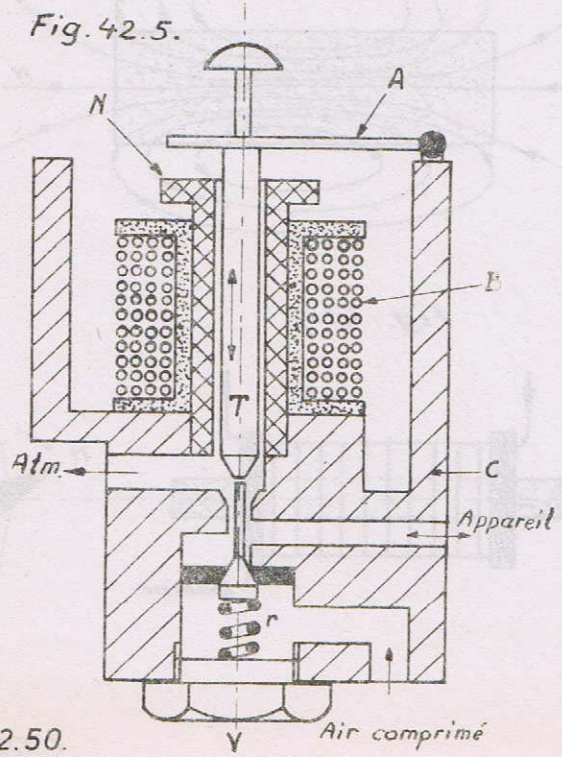

Fig. 42.6

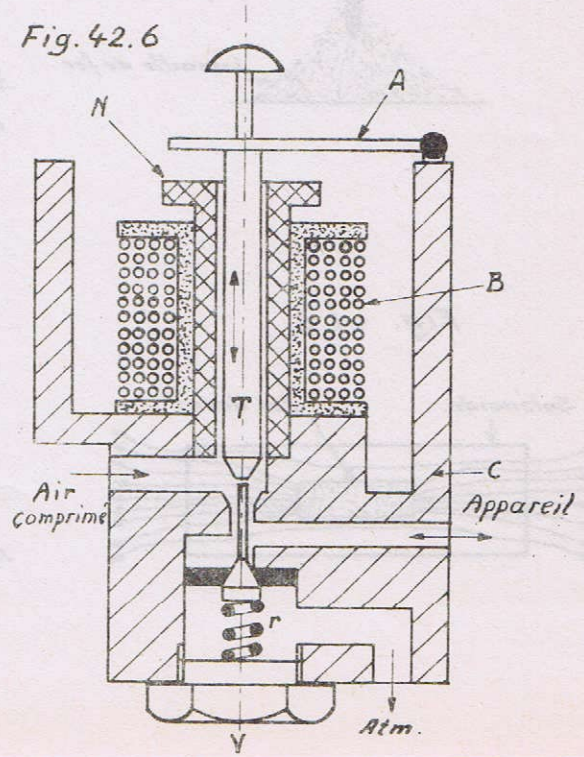

Fig. 43.1

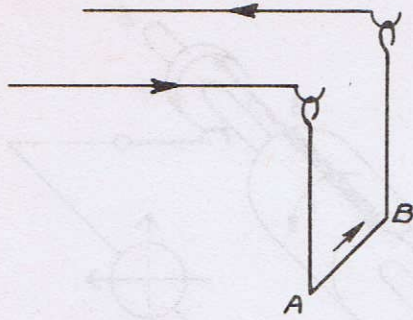

Fig. 43.2.

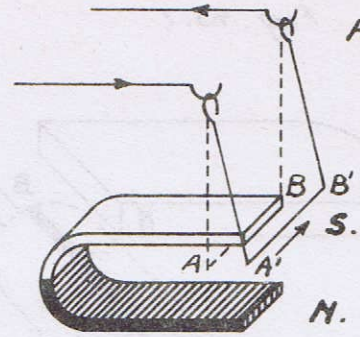

Fig. 43.3

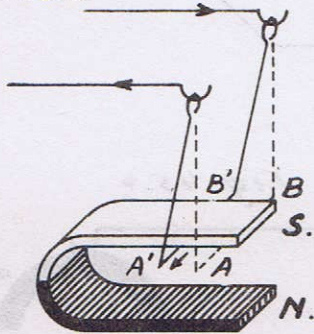

Fig. 43.4.

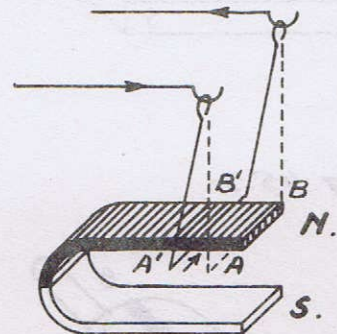

Fig. 43.5

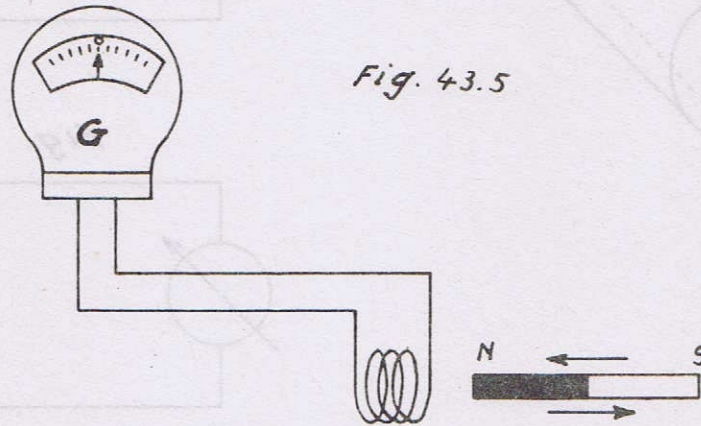

Fig. 43.6.

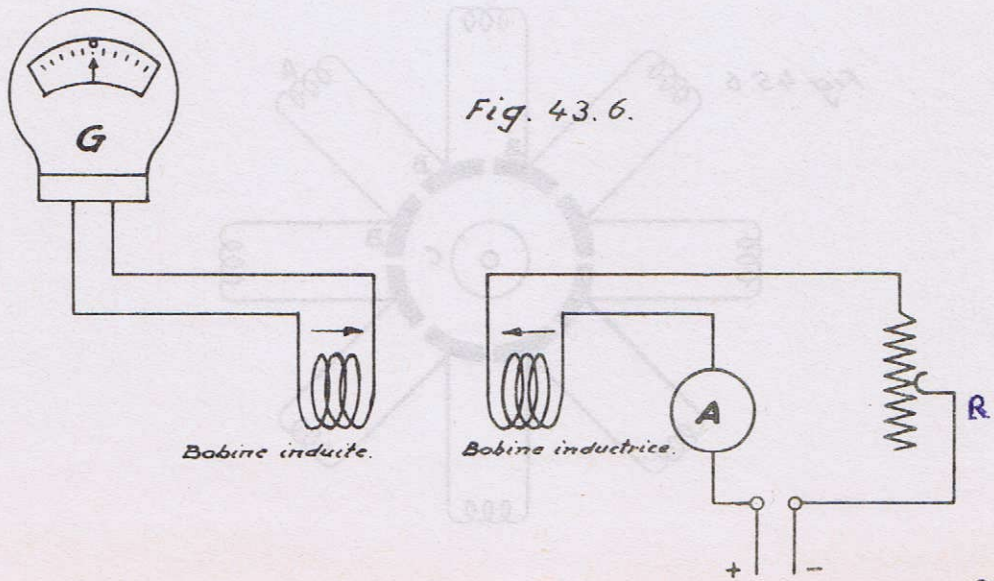

Fig. 45.1

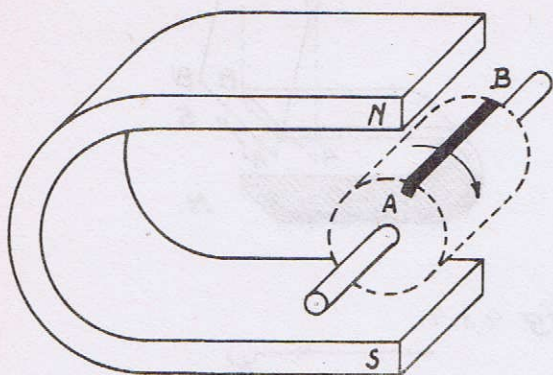

Fig. 45.2

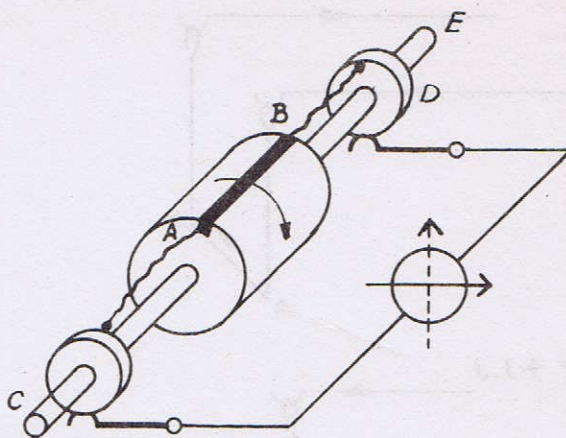

Fig. 45.3

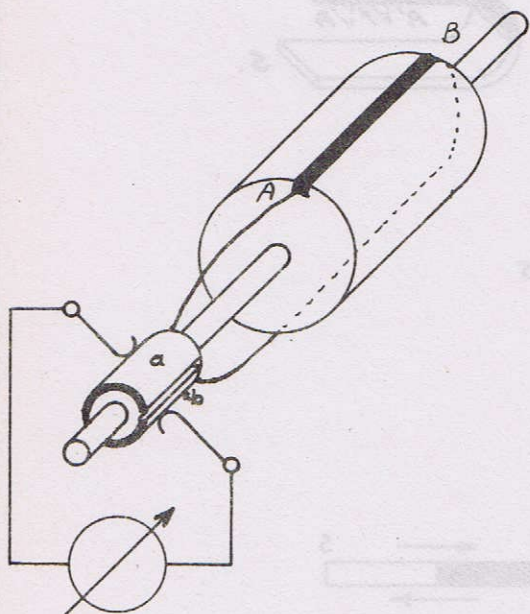

Fig. 45.4

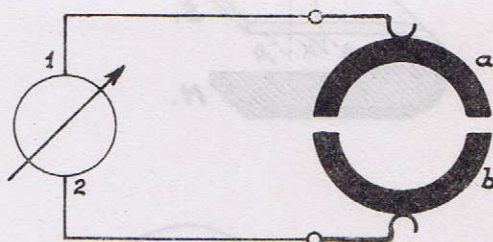
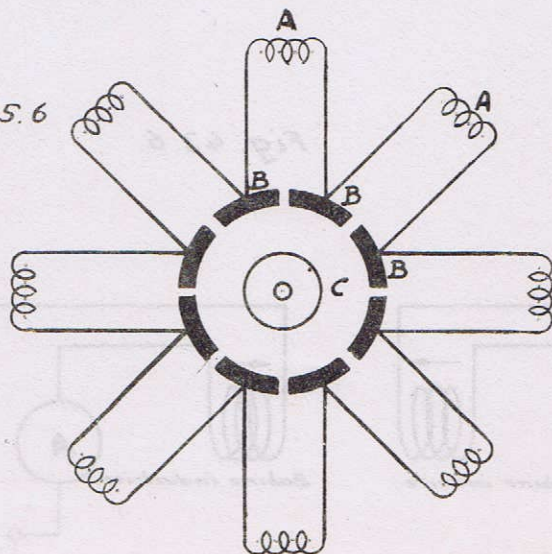

Fig. 45.5



Fig 45.6



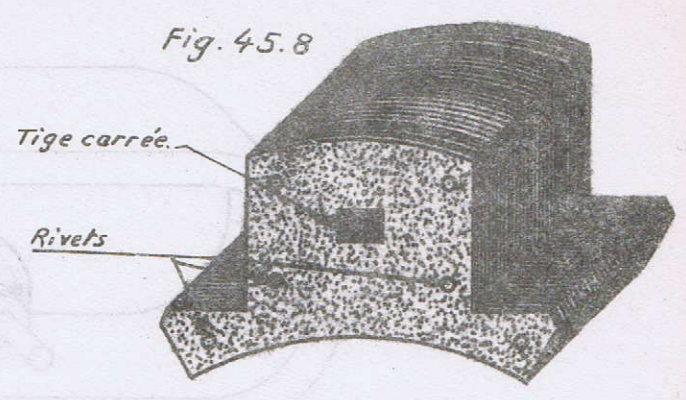
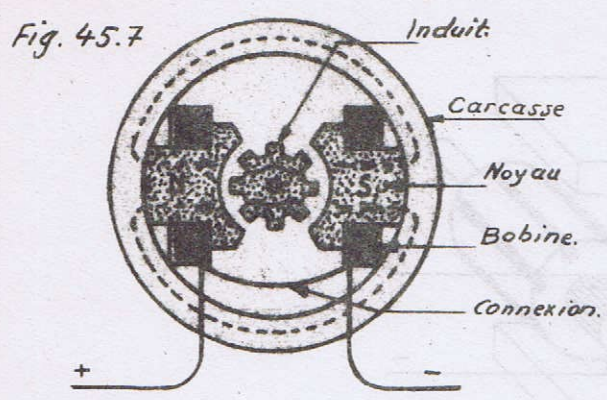

Fig. 45.9.



Fig. 45.10.

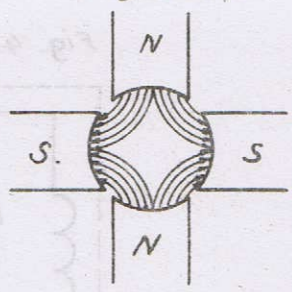

Fig. 45.11.

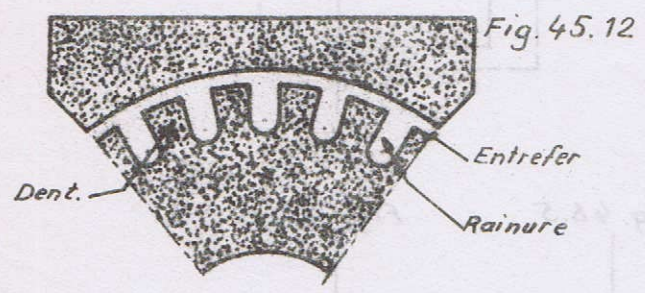
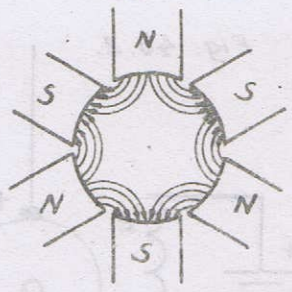

Fig. 45.13

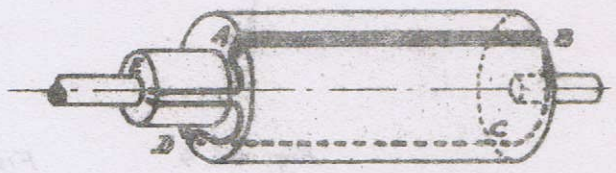
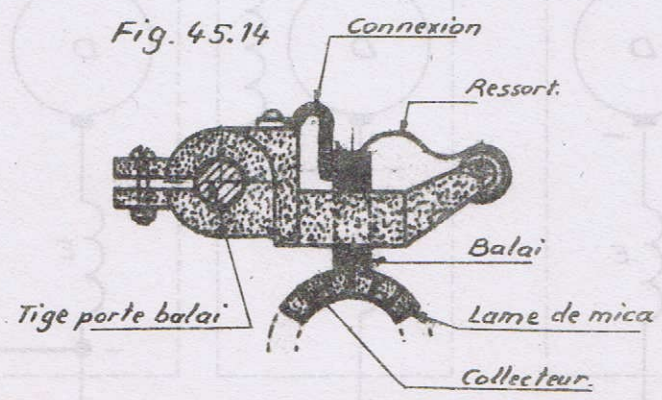

Fig. 45.14



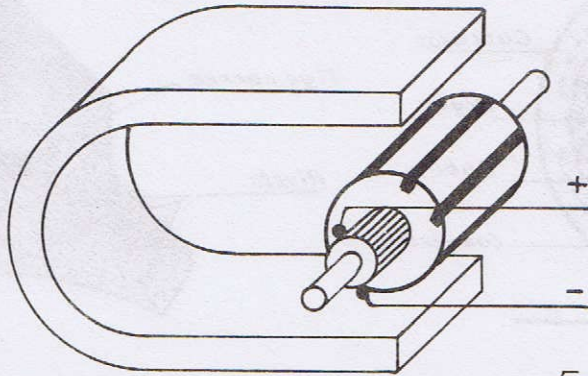

Fig. 46.1.

Fig. 46.2.

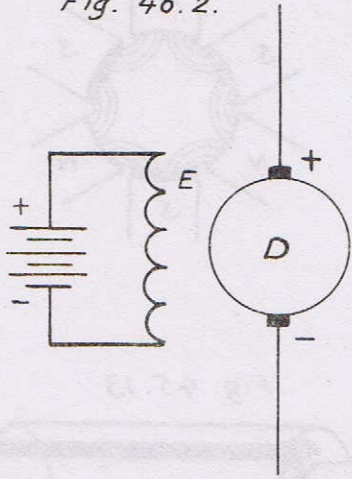

Fig. 46.3.

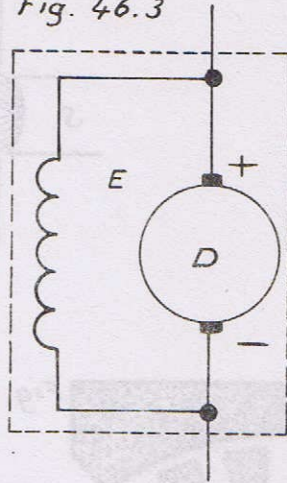

Fig. 46.4.

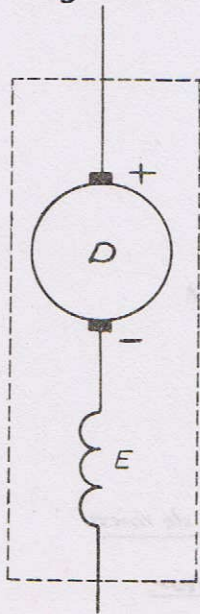

Fig. 46.5.

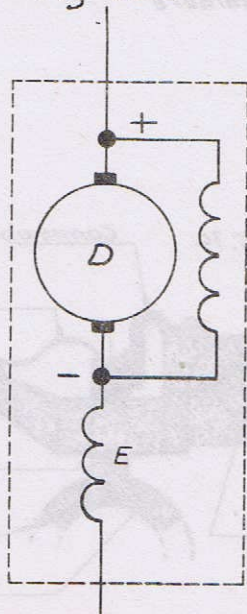

Fig. 46.6.

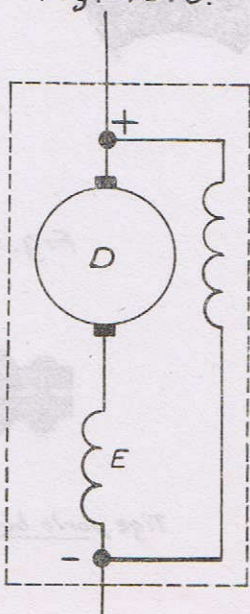

Fig. 47.1



Fig. 47.2

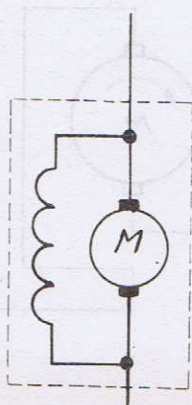

Fig. 47.3

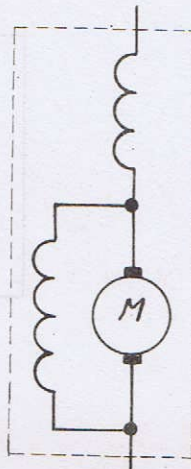

Fig. 47.4

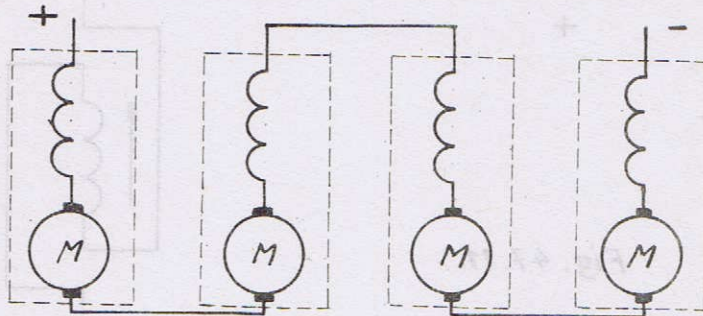
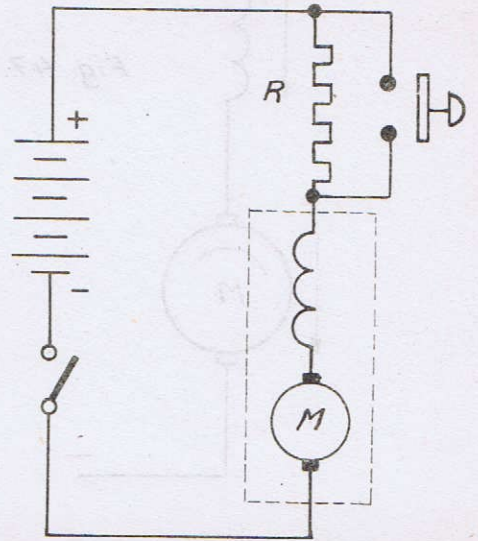

Fig. 47.5.

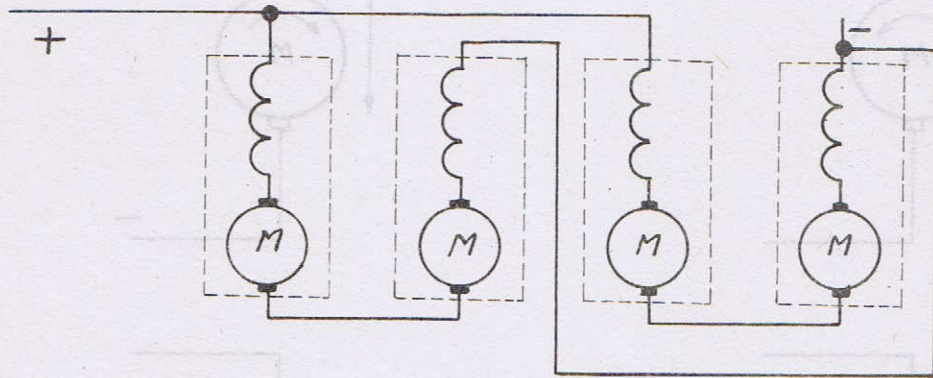

Fig. 47.6.

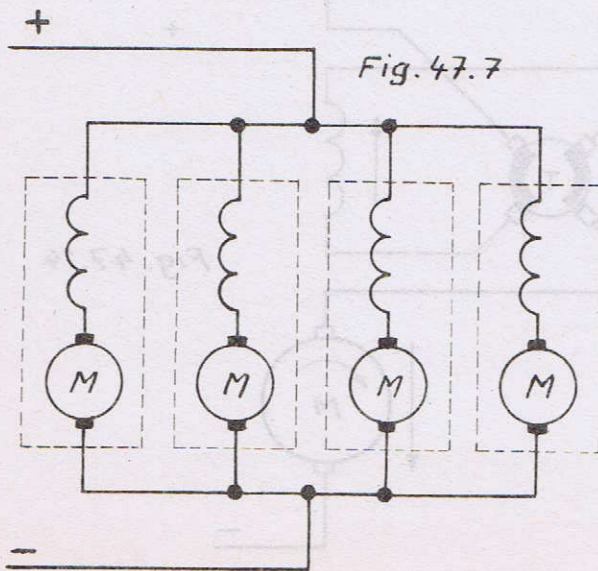

Fig. 47.7

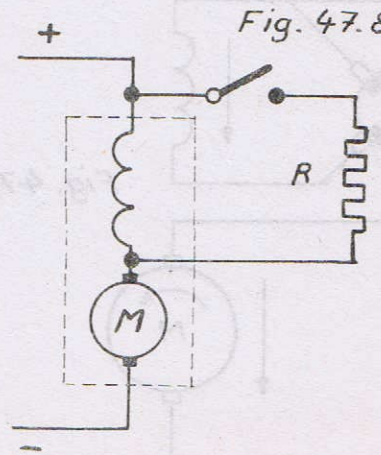
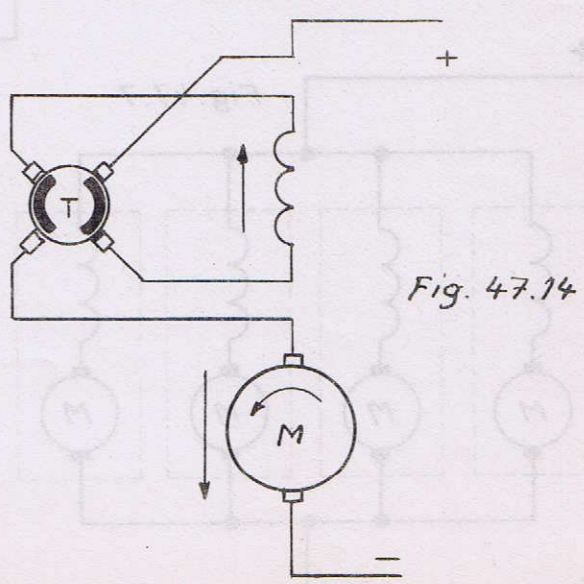
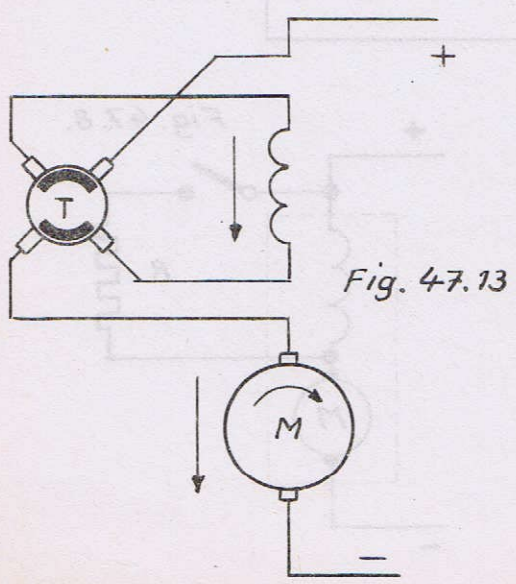
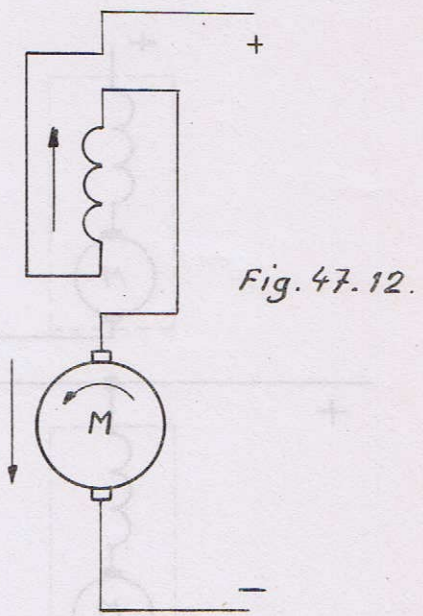
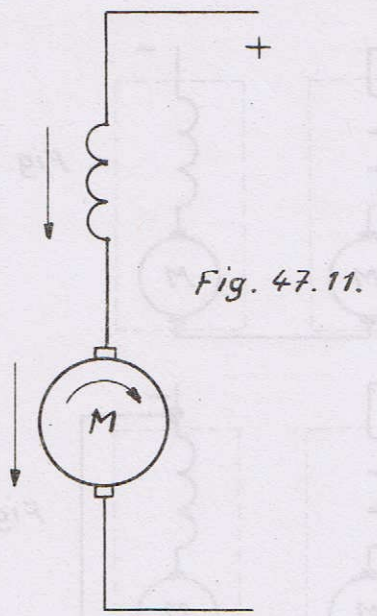
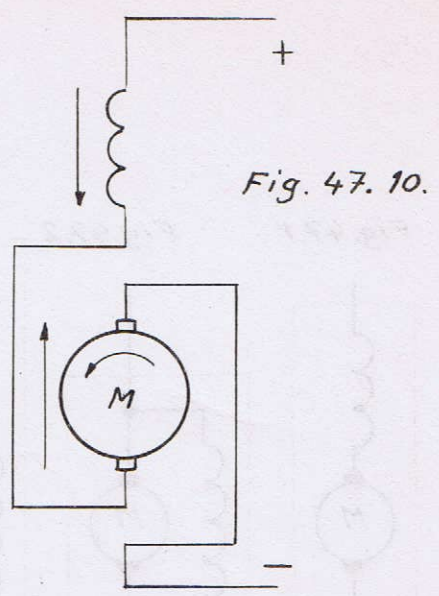
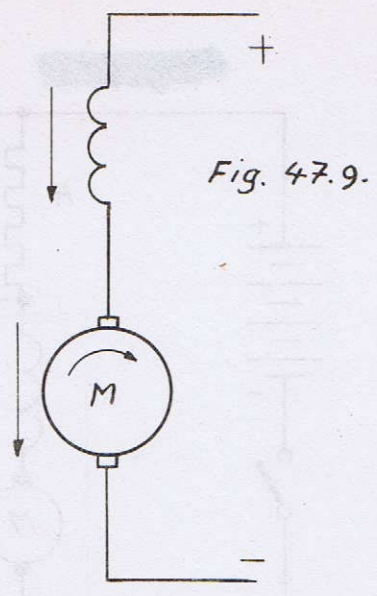

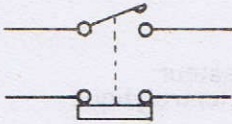

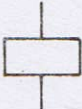
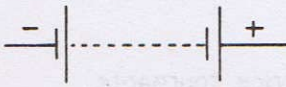

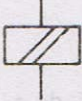



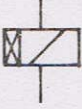
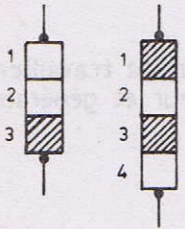

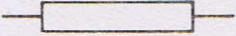
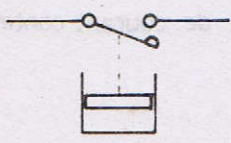
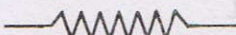
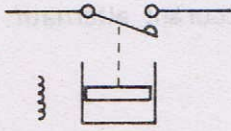
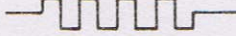
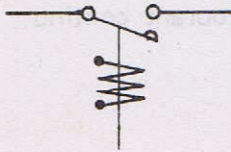
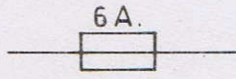

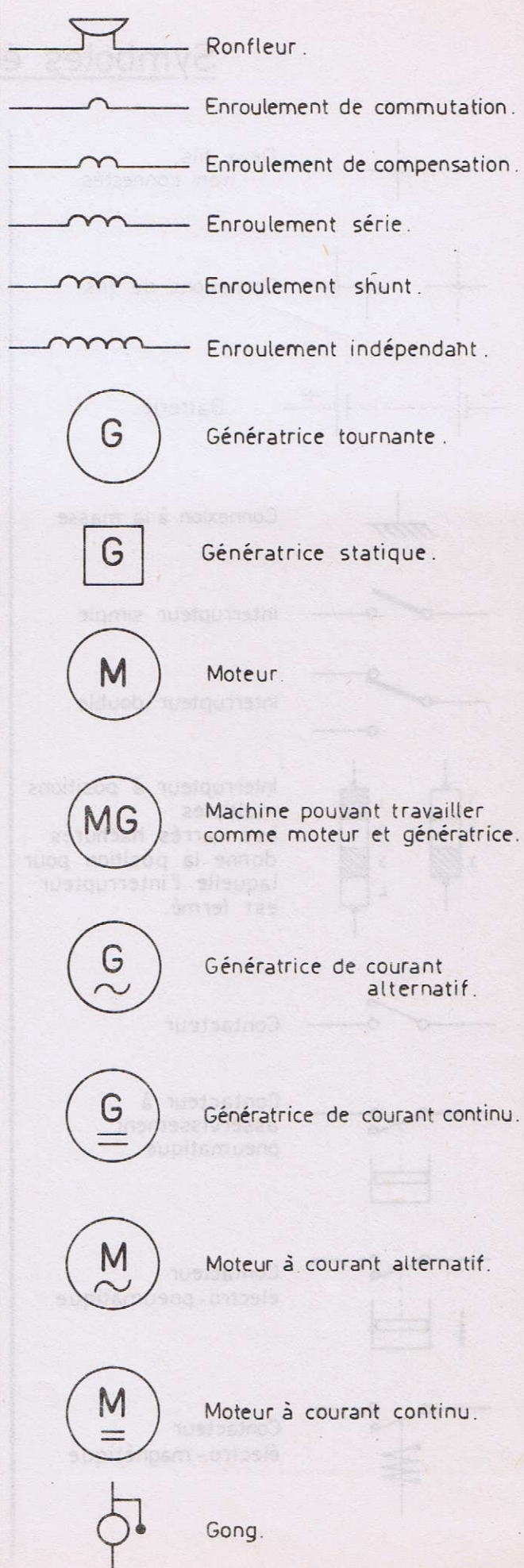
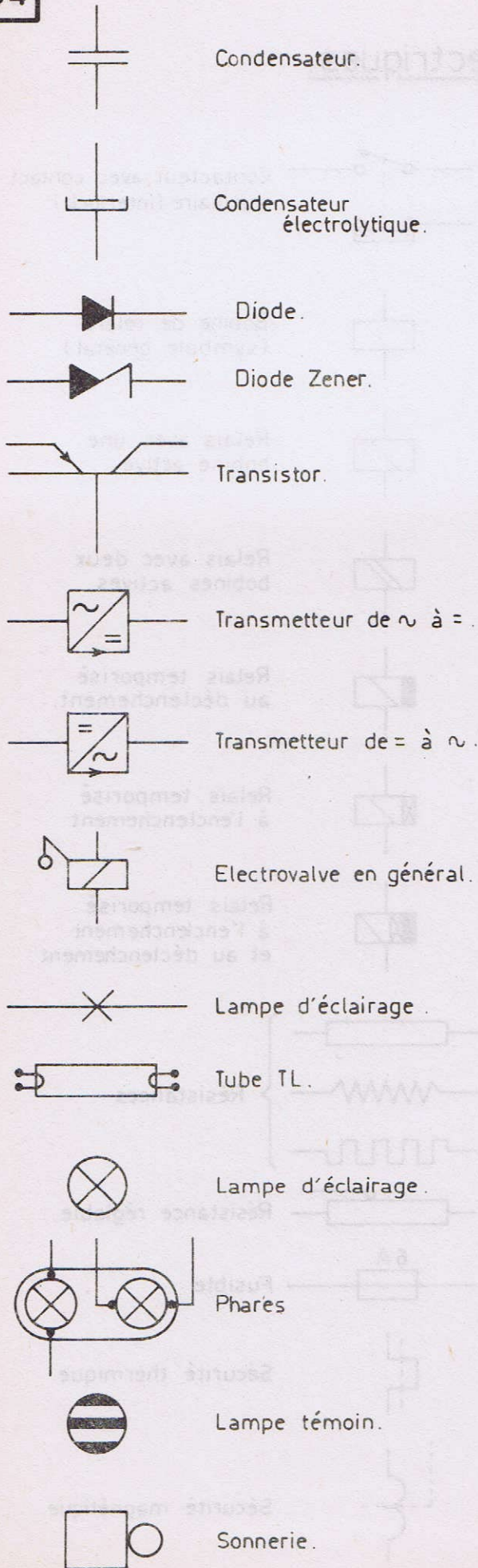

Fig. 47.8.



Symboles électriques.

	Deux fils, non connectés.		Contacteur avec contact auxiliaire (interlock).
	Connexions de fils.		Bobine de relais (symbole général).
	Batterie.		Relais avec une bobine active.
	Connexion à la masse		Relais avec deux bobines actives.
	Interrupteur simple.		Relais temporisé au déclenchement.
	Interrupteur double.		Relais temporisé à l'enclenchement.
	Interrupteur à positions multiples. Les carrés hachurés donne la position pour laquelle l'interrupteur est fermé.		Relais temporisé à l'enclenchement et au déclenchement.
	Contacteur		} Résistances
	Contacteur à asservissement pneumatique.		
	Contacteur électro-pneumatique.		
	Contacteur électro-magnétique.		Fusible
			Sécurité thermique.
			Sécurité magnétique.





Alternateur.



Moteur synchrone.



Moteur asynchrone.



Moteur de traction.



Génératrice principale.



Excitatrice.



Génératrice auxiliaire.

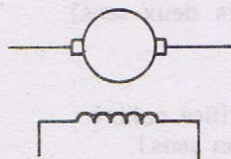

Génératrice à excitation indépendante.



Moteur ou dynamo série.

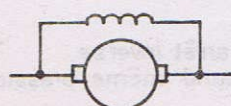

Moteur ou dynamo shunt.

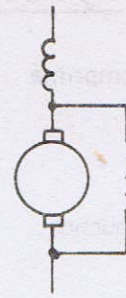

Moteur ou dynamo compound.

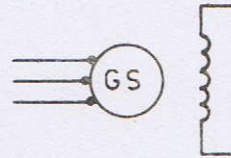

Génératrice à courant alternatif triphase

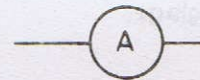

Ampèremètre

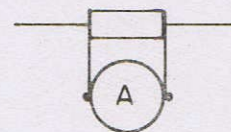

Ampèremètre sur shunt.

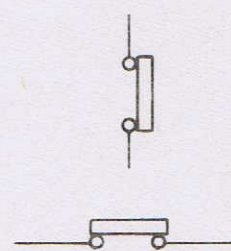

Contact s'ouvre quand la bobine est excitée.

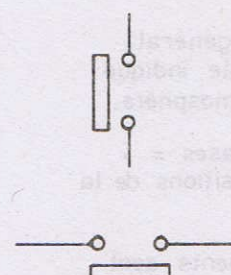

Contact se ferme quand la bobine est excitée.

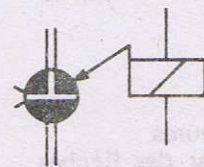



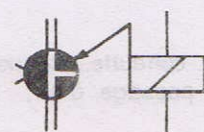

















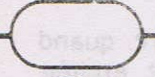







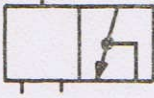

Electrovalve directe.

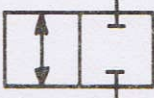

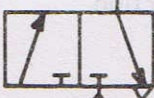
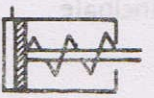
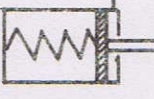
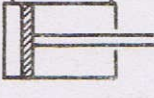
Electrovalve inverse.

Symboles pneumatiques.

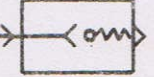
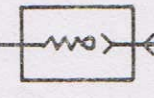
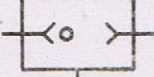
	Conduite d'air comprimé.
	Flexible
	Joint plein ou bouchon.
	Connexion.
	Croisement
	Direction.
	Direction.
	Ressort de rappel.
	Possibilité de réglage.
	Ressort de rappel à tension réglable.
	Robinet.
	Manomètre.
	Filtre.
	Réservoir.
	Pompe à vide.
	Compresseur.
	Soupape (en général) le petit triangle indique l'orifice à l'atmosphère.
	Nombre de cases = nombre de positions de la soupape
	Les raccordements sont indiqués à la case qui donne la position "Repos..."
	Liaisons intérieures, représentées par des flèches.
	Un trait sur la conduite indique obstruction au passage d'air.

	Lignes = conduites intérieures. Point = connexion intérieure.
	Soupape change de position conduites ouvertes en permanence air passe quand soupape se déplace.
	Soupape à 2 conduites et 2 positions. au repos : air ne passe pas.
	au repos : air passe.
	Soupape à 3 conduites et 2 positions. au repos : pas d'arrivée d'air, air du récepteur à l'atmosphère.
	Servo-moteur à simple effet l'air fait sortir la tige piston.
	Servo-moteur à simple effet. l'air fait rentrer la tige piston.
	Servo-moteur à double effet.
	Orifice diaphragme constant, (dans les deux sens).
	Orifice diaphragme réglable, (dans les deux sens).
	Soupape avec orifice calibré (dans un sens).
	Soupape de sûreté.
	Soupape de retenue. (sans ressort, se ferme par son propre poids).
	Double valve d'arrêt.
	Double valve d'arrêt inverse. (sortie ouverte quand même pression aux 2 entrées).

